

AMERICAN MUSEUM *Novitates*

PUBLISHED BY THE AMERICAN MUSEUM OF NATURAL HISTORY
CENTRAL PARK WEST AT 79TH STREET, NEW YORK, N.Y. 10024
Number 3104, 63 pp., 217 figures, 8 tables June 24, 1994

Systematics, Cladistics, and Biogeography of the Andean Weevil Genera *Macrostyphlus*, *Adioristidius*, *Puranius*, and *Amathynetoides*, New Genus (Coleoptera: Curculionidae)

JUAN J. MORRONE¹

ABSTRACT

The 38 species formerly assigned to *Macrostyphlus* Kirsch and 26 new species are revised, providing keys for identification, diagnoses, descriptions, illustrations, cladograms, and distributional maps. These species are assigned to *Macrostyphlus* sensu stricto, *Amathynetoides*, new genus, *Adioristidius* Voss, and *Puranius* Germain. *Macrostyphlus*, basically from the Paramo province of the northern Andes, comprises *M. coelorum* (Olliff), *M. gualcalae* Kirsch (type species), *M. transatlanticus* (Kirsch), and 7 new species: *M. bilbo*, *M. frodo*, *M. gandalf*, *M. howdenorum*, *M. peruvianus*, *M. sturmi*, and *M. venezolanus*. *Adioristidius* (= *Anchadoristus* Voss, new synonym), reinstated from synonymy with *Macrostyphlus*, is basically distributed in the Punan prov-

ince of Bolivia and Peru (4 Chilean species), and comprises (all new combinations) *A. anchonoideus* (Hustache), *A. carinicolis* (Voss), *A. costulatus* (Hustache), *A. crassirostris* (Hustache), *A. cuprisquameus* (Voss), *A. granulatus* (Hustache), *A. morio* (Voss), *A. nivalis* (Kuschel), *A. pampaensis* (Voss), *A. peruvianus* (Voss), *A. puncticolis* (Hustache), *A. scrobicolis* (Voss), *A. similaris* (Voss) (type species, here designated), *A. subimpressus* (Voss), *A. subtuberculatus* (Voss), *A. sulcicolis* (Hustache), *A. tuberculatus* (Voss), *A. variegatus* (Hustache), and 6 new species: *A. chilensis*, *A. hirsutus*, *A. hydanius*, *A. jorgei*, *A. lidiae*, and *A. manu*. *Amathynetoides* (= *Amathynetes* Kuschel [not *Amathynetes* Olliff], new synonym), from the Punan province of Bolivia and Peru, is described

¹ Research Associate, Department of Entomology, American Museum of Natural History; Laboratorio de Sistemática y Biología Evolutiva (LASBE), Museo de La Plata, Paseo del Bosque, 1900 La Plata, Argentina.

for the following species (all new combinations): *A. appendiculatus* (Kuschel) (type species), *A. ebeninus* (Hustache), *A. longulus* (Kuschel), *A. nitidiventris* (Hustache), *A. palustris* (Kuschel), *A. sparsesetosus* (Hustache), and 4 new species: *A. intemperatus*, *A. morbeamus*, *A. normae*, and *A. sundrianus*. *Puranius* (= *Reichertia* Enderlein), reinstated from synonymy with *Macrostyphlus*, is found in the Subantarctic and Andeanpatagonian dominions of Argentina, Chile, Bolivia, and Peru, and comprises *P. australis* Germain, *P. championi* (Kuschel), *P. dubius* (Germain), *P. exsculpticollis* (Enderlein), *P. fasciculiger* (Blanchard), *P. hispidus* (Germain), *P. inaequalis* Germain (type species, here designated), *P. nigrinus* (Fairmaire), *P. scaber* (Enderlein), *P. tuberosus* Germain, *P. verrucosus*

(Germain), and 9 new species: *P. argentinensis*, *P. elguetai*, *P. midas*, *P. obrienorum*, *P. pusillus*, *P. sylvanius*, *P. torosus*, *P. tothus*, and *P. vulgaris*. Two generalized tracks were identified: northern (for *Macrostyphlus*, *Acrorius* Kirsch, and *Nacodius* Morrone), and central-southern (for *Adioristidius*, *Amathynetoides*, *Puranius*, *Listroderes* Schoenherr, and other Subantarctic genera). Areas of endemism belonging in both tracks were cladistically analyzed. The northern track was fragmented according to the following sequence: ((Venezuela (Colombia, northern Ecuador)), (southern Ecuador, northwestern Peru, southern Peru)). In the central-southern track, the following sequence resulted: (Punan province (Central Chile (Subantarctic dominion, northwestern Argentina)))

INTRODUCTION

The 38 species formerly placed in *Macrostyphlus* Kirsch (Wibmer and O'Brien, 1986) have never been revised. These South American species occur in the Andes, from Colombia and Venezuela to southern Chile, with three species on the Falkland Islands and one species in northwestern Argentina. Because of their similarity, Kuschel (1986) considered lumping these species, originally described under different generic names, into a single genus.

This heterogeneous assemblage, however, is mainly based on plesiomorphic characters. I therefore prefer to recognize as valid genera four major monophyletic groups included in it: *Macrostyphlus* sensu stricto, *Adioristidius* Voss, *Puranius* Germain, and *Amathynetoides*, new genus. These four genera as here defined have more restricted distributions than *Macrostyphlus* sensu lato: *Macrostyphlus* is found in the Paramo province of the northern Andes, *Adioristidius* and *Amathynetoides* are largely sympatric in the Punan biogeographic province of Bolivia and Peru, and *Puranius* is widely ranged in the Subantarctic and Andeanpatagonian dominions of the southern Andes. Some overlap, however, occurs in southern Peru, where species of the four genera are found.

My objectives are:

(1) to redescribe the genera *Macrostyphlus*, *Adioristidius*, and *Puranius*, and to describe *Amathynetoides*;

(2) to revise their species, providing diag-

noses, descriptions, illustrations, and distributional maps;

(3) to perform their cladistic analyses; and

(4) to analyze their distributional patterns, by comparing them with other taxa inhabiting their same areas of endemism.

ACKNOWLEDGMENTS

I express my appreciation to María M. Cigliano, María del C. Coscarón, Lee H. Herman, Jr., and Analía A. Lanteri for critically reading the manuscript. I also thank the people who made possible the loan of specimens.

This study was supported by a National Science Foundation Research Fellowship at the Department of Entomology of the American Museum of Natural History (New York, USA). I belong to the Consejo Nacional de Investigaciones Científicas y Técnicas (CONICET), Argentina, whose continuous support I acknowledge.

COLLECTIONS EXAMINED

AMNH	American Museum of Natural History, New York, USA (Lee H. Herman, Jr.)
AMPC	Amyan MacFadyen, private collection, Coleraine, Northern Ireland (Amyan MacFadyen)
BMNH	The Natural History Museum, London, England (Christopher Lyal)
BPBM	Bernice P. Bishop Museum, Honolulu, USA (G. A. Samuelson)

CADIC	Centro Austral de Investigaciones Científicas, Ushuaia, Tierra del Fuego, Argentina (Alvar Sobral)
CMN	Canadian Museum of Nature, Ottawa, Canada (Robert S. Anderson)
CNCI	Canadian National Collection of Insects, Center for Land and Biological Resources Research, Biological Research Division, Agriculture Canada, Ottawa, Canada (Donald E. Bright)
CWOB	Charles W. O'Brien, private collection, Tallahassee, Florida, USA (Charles W. O'Brien)
DEI	Deutsches Entomologisches Institut, Eberswalde-Finow, German Federal Republic (Lothar Zenche)
FIML	Fundación e Instituto Miguel Lillo, San Miguel de Tucumán, Argentina (Arturo L. Terán)
FMNH	Field Museum of Natural History, Chicago, USA (A. F. Newton, Jr.)
HAHC	Henry F. and Anne T. Howden, private collection, Ottawa, Canada (Anne T. Howden)
ICNB	Instituto de Ciencias Naturales, Universidad Nacional de Colombia, Santafé de Bogotá, Colombia (Gonzalo Andrade)
IPUM	Instituto de la Patagonia, Universidad de Magallanes, Punta Arenas, Chile (José Petersen)
MCZ	Museum of Comparative Zoology, Harvard University, Cambridge, USA (David G. Furth)
MHNS	Museo Nacional de Historia Natural, Santiago, Chile (Mario Elgueta)
MLP	Museo de La Plata, La Plata, Argentina (Ricardo A. Ronderos)
NZAC	New Zealand Arthropod Collection, Auckland, New Zealand (Robin Craw)
USNM	National Museum of Natural History, Washington D.C., USA (James Pakaluk)

METHODS

Measurements were made with an ocular micrometer in a stereoscopic microscope. Body length was measured dorsally, along the midline, from the elytral apex to the fore margin of pronotum. Drawings were made with a camera lucida attached to the stereoscopic microscope. Exact label data are cited only for the type material, where separate labels are indicated by square brackets, and separate lines by slashes.

Cladistic methods are detailed in Forey et al. (1992). Cladistic analyses were performed with Hennig86 version 1.5 (Farris, 1988). Multistate characters were treated as unordered. Implicit enumeration option was used for *Macrostyphlus* and *Amathynetoides*; *mhennig** and *branch-breaking** was used for *Adioristidius* and *Puranius*.

As the relationships between these genera are still unknown, the more basal genus *Listroderes* Schoenherr (Morrone, 1993b, c, in press a, b) was chosen to root the cladograms. CLADOS version 1.1 (Nixon, 1992) was employed for examination of character distributions.

Cladistic biogeographic principles are detailed in Nelson and Platnick (1981), Nelson (1984), and Humphries and Parenti (1986). A two-step approach proposed by Morrone and Crisci (1990) was applied:

(1) generalized tracks (Croizat, 1958, 1964) were initially recognized; and

(2) separate cladistic biogeographic analyses (Nelson and Platnick, 1981) of the areas of endemism of each track were then carried out.

Generalized tracks were identified by looking for coincidence among patterns of distribution shown by different genera of Rhytirrhini. For obtaining the area cladograms for the cladistic analyses, widespread taxa in the taxon-area cladograms were reduced in favor of endemics, as suggested by Nelson and Ladiges (1991a, b). In order to obtain the general area cladograms, three different methods were applied:

(a) component analysis (Nelson and Platnick, 1981; Nelson, 1984; Page, 1990) with options BUILD and SHARED of Component version 1.5 (Page, 1989);

(b) Brooks Parsimony Analysis (BPA) (Brooks, 1985, 1990; Wiley, 1988) with Hennig86 (Farris, 1988); and

(c) Three Area Statements (TAS, Nelson and Ladiges, 1991a, c), with TAS (Nelson and Ladiges, 1991b).

Items of error (Nelson and Platnick, 1981) were calculated by mapping taxon-area cladograms onto the general area cladograms, with option FIT of Component version 1.5 (Page, 1989). These items of error were used to evaluate the general area cladograms obtained by the different methods.

HISTORICAL REVIEW

Kirsch (1889) described the genus *Macrostypylus* for *M. gualcalae*, from the Andes of Colombia.

Germain (1896), in his monograph of the Chilean Listroderini (Rhytirrhini sensu Kuschel, 1990), described *Puranius* for three species from central and southern Chile.

Enderlein (1912) described *Reichertia* for three species from the Falkland Islands that he previously (Enderlein, 1907) had described in *Listroderes*.

Voss (1954) described *Adioristidius* and *Anchadoristus*, as subgenera of *Adioristus* Waterhouse [now synonym of *Cylydrorhinus* Guérin, Entimini], for two groups of species from Bolivia and Peru.

Kuschel (1949), while studying the weevil fauna of northern Chile, described new species for *Amathynetes* Olliff [another current synonym of *Cylydrorhinus*], transferred to it some species originally described by Germain (1896) in *Listroderes* and by Hustache (1938a, b) in *Hyperodes* Jekel, and treated *Puranius* and *Reichertia* as synonyms of *Puranius*. In 1955, Kuschel realized that he had misidentified *Amathynetes*, and reinstated *Puranius* to include the species previously assigned to it.

Finally, Kuschel (1986) considered that all these names were synonyms of *Macrostypylus*.

SYSTEMATICS

The genera *Macrostypylus*, *Adioristidius*, *Amathynetoides*, and *Puranius* belong to the subtribe Listroderina of the tribe Rhytirrhini. They are recognized by two characters:

(1) presence of a suprascrobal keel (except in some species of *Adioristidius* where it is lost);

(2) deep scrobes (also present in distantly related genera *Listronotus* Jekel, *Neopachytychius* Hustache, and *Haversiella* Schweig-er).

In addition, the following characters are common to the four genera.

Eyes ovate; rostrum shorter than pronotum; scrobes usually subtriangular, lateral, directed toward eyes, ventral carina lacking teeth; pterygia developed; epistome not pro-

truding; antennae subapically inserted, with funicular article 1 longer than 2, and articles 3–6 usually monilliform; metepisternal suture usually absent; scutellum visible; elytra convex, wider than pronotum; apical declivity smooth, anteapical tubercle absent; legs with robust femora and tarsomere 3 bilobate; aedeagus symmetrical, sclerotized, tegmen lacking parameres; female sternum 8 with long to very long apodemes; hemisternites usually with baculi; and spermatheca usually with enlarged ramus and nodulus absent.

Remarks: The presence of a suprascrobal keel and deep scrobes may be regarded as synapomorphies supporting the monophyly of this generic group. But until a cladistic analysis involving the other genera of Rhytirrhini is undertaken, this will be speculative. In particular, exact limits with the *Falklandius* generic group (Morrone and Anderson, in prep.) should be determined.

KEY TO *MACROSTYPYLUS*
AND RELATED GENERA

1. Pronotum subcylindrical (fig. 1), lacking postocular lobes; female hemisternites lacking baculi *Macrostypylus* Kirsch
- 1a. Pronotum not subcylindrical, usually with postocular lobes; female hemisternites usually with baculi 2
2. Antenna with inflated club; pronotum transverse to strongly transverse (fig. 4); elytra short-ovate (fig. 4) *Puranius* Germain
- 2a. Antenna with ovate club; pronotum subcircular (fig. 2) or with subparallel flanks (fig. 3); elytra ovate to elongate-ovate (figs. 2, 3) 3
3. Integument rugose; pronotum subcircular (fig. 2); elytra with abundant setae *Adioristidius* Voss
- 3a. Integument smooth; pronotum with subparallel flanks (fig. 3); elytra with sparse setae *Amathynetoides*, n. gen.

MACROSTYPYLUS KIRSCH

Type species: *M. gualcalae* Kirsch, 1889 (by indication, monotypy).

Macrostypylus Kirsch, 1889: 25; Schenkling and Marshall, 1931: 4 (cat.); Blackwelder, 1947: 814 (checklist); Kuschel, 1955: 271 (from Rhyparosominae to Cylydrorhininae); Sturm and Rangel, 1985: 151 (biogeogr.); Wibmer and O'Brien, 1986: 116 (checklist); Elgueta, 1988: 134 (biogeogr.).

DIAGNOSIS: The species of this genus are recognized by the subcylindrical pronotum.

REDESCRIPTION: Very small (body length 1.9–3.5 mm). Integument rugose, dark brown. Body vestiture generally of thin, slightly striate, subcircular scales and setae. Frons lacking fovea. Eyes medium-sized (as long as rostrum height) to small (as long as half of rostrum height), flat; supraocular sulcus absent. Rostrum with three slender, dorsal keels; setose. Antennae with funicular articles 3–6 usually monilliform; club inflated. *Pronotum* (fig. 1) subcylindrical, longer than wide; not tuberculate; postocular lobes absent. Metepisternal suture absent. Scutellum prominent or not. *Elytra* (fig. 1) ovate, with rounded humeri; setae simple, usually curved, tapered. *Legs* with tibiae usually mucronate; with 1–2 spurs or lacking them; squamose.

Male Genitalia: Aedeagus usually with rounded apex (fig. 32), apodemes slightly longer than body.

Female Genitalia: Sternum 8 with apodeme usually very long (figs. 12–14); plate subcircular, sclerotized arms usually long, reaching apex. Hemisternites elongate (fig. 15) or subtriangular (fig. 24); lacking baculi; styli present. Spermatheca with ramus usually enlarged (fig. 18).

BIOLOGY: *Macrostyphlus venezolanus* and *M. peruvianus* have been collected in litter; *M. venezolanus* was collected from leaf bases of *Espeletia* [Asteraceae]. According to Sturm and Rangel (1985), species of *Macrostyphlus* were found in dead leaves of this plant.

CLADISTICS: The following characters were analyzed:

1. EYES. [0] large (longer than rostrum height); [1] medium-sized (as long as rostrum height); [2] small (as long as half of rostrum height).
2. SCAPE. [0] exceeding hind margin of eye when resting in scrobe; [1] reaching hind margin of eye when resting in scrobe.
3. SCAPE. [0] gradually widening toward apex; [1] inflated.
4. PRONOTAL MEDIAN CARINA. [0] absent; [1] present.
5. ELYTRAL TUBERCLES. [0] absent; [1] present.
6. BASE OF ELYTRAL INTERVAL 3. [0] flat; [1] tuberculate.

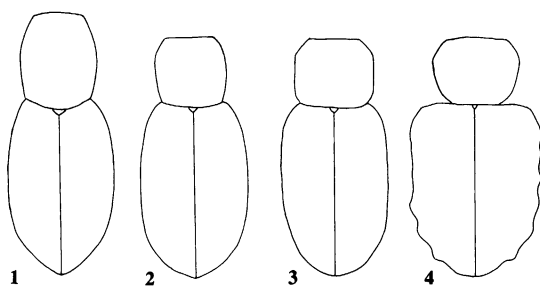

Figs. 1–4. External morphology; pronotum + elytra. 1, *Macrostyphlus venezolanus*; 2, *Adioristidius nivalis*; 3, *Amathynetoides ebeninus*; 4, *Puranius australis*.

7. ELYTRAL SETAE. [0] slender; [1] strong.
8. ELYTRAL SETAE. [0] curved, tapered; [1] straight, blunt.
9. TIBIAE. [0] mucronate; [1] lacking mucro.
10. TIBIAL SPURS. [0] two; [1] one; [2] absent.
11. STERNITES. [0] lacking scales; [1] squamose.
12. PLATE OF FEMALE STERNUM 8. [0] sinuate (fig. 27); [1] entire (fig. 12); [2] open (fig. 23).

The analysis of the data matrix (table 1) led to one single cladogram (fig. 5), with 30 steps, a consistency index of 0.50, and a retention index of 0.50. *Macrostyphlus peruvianus* is the sister species to the remaining, which are arranged in two clades, one including *M. frodo*, *M. bilbo*, and *M. howdenorum*, and the other one including *M. gualcalae* plus *M. coelorum*, *M. venezolanus*, *M. sturmi*, *M. gandalf*, and *M. transatlanticus*.

GEOGRAPHICAL DISTRIBUTION: Nine species of *Macrostyphlus* are endemic to the northern Andes: four species in Ecuador (*M. bilbo*, *M. coelorum*, *M. howdenorum*, and *M. transatlanticus*), four in Colombia (*M. gualcalae*, *M. frodo*, *M. sturmi*, and *M. gandalf*), and one in Venezuela (*M. venezolanus*) (fig. 11), in the Paramo biogeographic province of the Amazonian dominion (Cabrera and Willink, 1973). One species, *M. peruvianus*, extends the range of the genus to southern Peru.

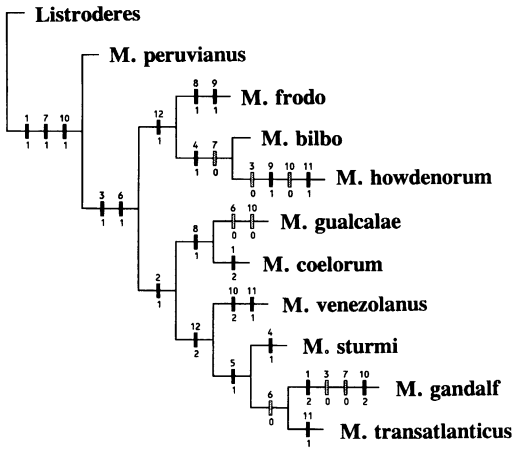

Fig. 5. Cladogram of species of the genus *Macrostyphlus*.

Macrostyphlus is part of a northern generalized track shared with *Acrorius* Kirsch (Morrone, 1994a) and *Nacodius* Morrone (Morrone, 1994b). The area cladograms of these three genera were obtained by replacing the relevant areas of endemism (fig. 6) and reducing widespread taxa (figs. 7–9). Component analysis under assumptions 0, 1 and 2, BPA (data matrix in table 2), and TAS (data matrix in table 3), led to the same three general area cladograms, for which the strict consensus tree is shown in figure 10. Items of error gave the same value (14) for all of them. According to these results:

(1) A first vicariant event separated the

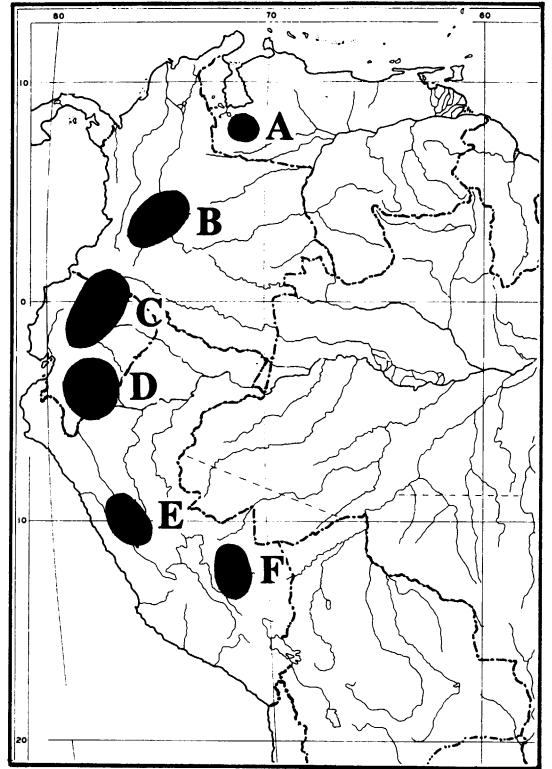

Fig. 6. Areas of endemism relevant to the analysis of *Macrostyphlus*, *Acrorius*, and *Nacodius*. A = Venezuela; B = Colombia; C = northern Ecuador; D = southern Ecuador; E = northwestern Peru; F = southern Peru.

northern areas (A, B, C) from the southern ones (D, E, F);

(2) Venezuela (A) was separated from Colombia (B) plus northern Ecuador (C);

(3) Colombia (B) was separated from northern Ecuador (C);

(4) all the three possibilities exist for the separation of the southern areas: southern Ecuador (D), northwestern Peru (E), and southern Peru (F).

TABLE 1
Data Matrix for *Macrostyphlus* Kirsch

	1											
	1	2	3	4	5	6	7	8	9	0	1	2
<i>Listroderes</i>	0	0	0	0	0	0	0	0	0	0	0	0
<i>M. bilbo</i>	1	0	1	1	0	1	0	0	0	1	0	1
<i>M. coelorum</i>	2	1	1	0	0	1	1	1	0	1	0	0
<i>M. frodo</i>	1	0	1	0	0	1	1	1	1	1	0	1
<i>M. gandalf</i>	2	1	0	0	1	0	0	0	0	2	0	2
<i>M. gualcalae</i>	1	1	1	0	0	0	1	1	0	0	0	?
<i>M. howdenorum</i>	1	0	0	1	0	1	0	0	1	0	1	1
<i>M. peruvianus</i>	1	0	0	0	0	1	0	0	1	0	0	0
<i>M. sturmi</i>	1	1	1	1	1	1	1	0	0	1	0	?
<i>M. transatlanticus</i>	1	1	1	0	1	0	1	0	0	1	1	?
<i>M. venezolanus</i>	1	1	1	0	0	1	1	0	0	2	1	2

KEY TO SPECIES OF *MACROSTYPHUS* KIRSCH

1. Body vestiture of setalike scales and setae; Peru *M. peruvianus*, n. sp.
- 1a. Body vestiture of subcircular scales and setae 2
2. Tibiae mucronate 3
- 2a. Tibiae lacking mucro 9
3. Pronotum with median carina 4

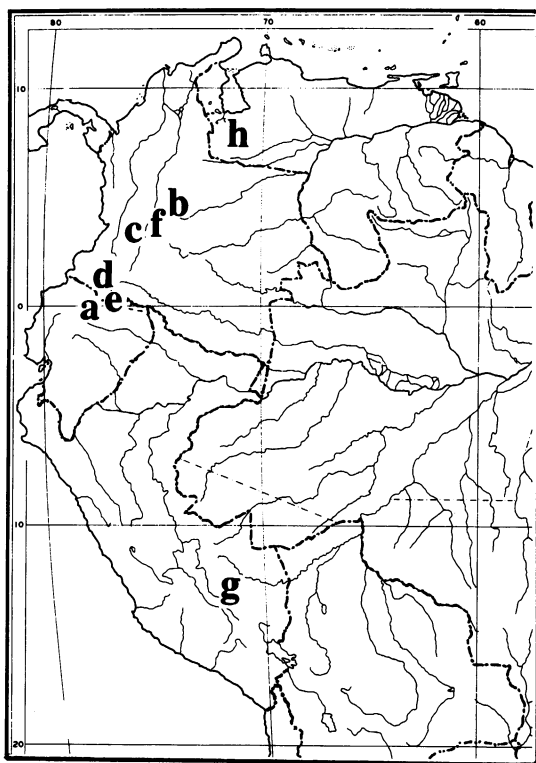

Fig. 11. Geographical distribution of the genus *Macrostyphlus*. a, *M. bilbo*, *M. coelorum*, and *M. transatlanticus*; b, *M. frodo*; c, *M. gandalf*; d, *M. gualcalae*; e, *M. howdenorum*; f, *M. sturmi*; g, *M. peruvianus*; h, *M. venezolanus*.

Scrobes linear; suprascrobal keel fine. Antenna with scape inflated, exceeding hind margin of eye when resting in scrobe; funicular articles 3–6 monilliform. *Pronotum* with apical impression well developed; median carina present; sulcus and lateral impressions absent; densely squamose. Scutellum prominent. *Elytra* with flat intervals; not tuberculate; base of interval 3 prominent; setae slender, curved, tapered. *Sternites* lacking scales. *Legs* with tibiae mucronate; with one spur each. *Body length* 2.6 mm.

Female Genitalia: Sternum 8 (fig. 12) with very long apodeme ($3.0\times$ longer than plate); plate with entire apex, with long setae; arms long, reaching apex. Hemisternites (fig. 15) elongate, $3.8\times$ longer than wide. Spermatheca (fig. 18) with enlarged ramus.

Male: Unknown.

GEOGRAPHICAL DISTRIBUTION: Known only

from the type locality in northern Ecuador (fig. 11).

TYPE MATERIAL: Holotype female with the following labels: [ECUADOR, Pich./ 46 km E Quito/ 13,500' III.2.1976/ J. M. Campbell] [CANADIAN NATIONAL/ COLLECTION-AGRICULTURE/ CANADA, OTTAWA] [*Macrostyphlus/ bilbo* Morrone/ holotype female] (CNCI).

ETYMOLOGY: The name of this species, a noun in apposition, is based upon Bilbo, from Tolkien's *The Lord of the Rings*.

Macrostyphlus coelorum (Olliff)

Figures 13, 16, 19

Macrops coelorum Olliff, 1891: 72.

Hyperodes coelorum; Cockerell, 1906: 246; Blackwelder, 1947: 814 (checklist).

Puranius coelorum; Kuschel, 1955: 290.

Macrostyphlus coelorum; Kuschel, 1986: 116; Wibmer and O'Brien, 1986: 116 (checklist).

DIAGNOSIS: This species is recognized by its small eyes (as long as half of rostrum height).

REDESCRIPTION: Body vestiture of subcircular scales and setae. Eyes small (as long as half of rostrum height). Scrobes subtriangular; suprascrobal keel fine. Antenna with scape inflated, reaching hind margin of eye when resting in scrobe; funicular articles 3–6 monilliform. *Pronotum* lacking apical impression, median carina, sulcus, and lateral impressions; densely squamose. Scutellum prominent. *Elytra* with slightly convex intervals; not tuberculate; base of interval 3 prominent; setae strong, straight, or slightly curved, blunt. *Sternites* lacking scales. *Legs* with tibiae mucronate; with one spur each. *Body length* 2.3 mm.

Female Genitalia: Sternum 8 (fig. 13) with very long apodeme ($2.5\times$ longer than plate); plate with sinuate apex, with short setae; arms long, reaching apex. Hemisternites (fig. 16) elongate, $4.5\times$ longer than wide. Spermatheca (fig. 19) with enlarged ramus.

Male: Unknown.

GEOGRAPHICAL DISTRIBUTION: Known from northern Ecuador (fig. 11).

MATERIAL EXAMINED: ECUADOR. PICHINCHA: 15 km W Papallacta, "under stones," 29-IV-1978, C. W. and L. O'Brien and Marshall, 1 (CWOB).

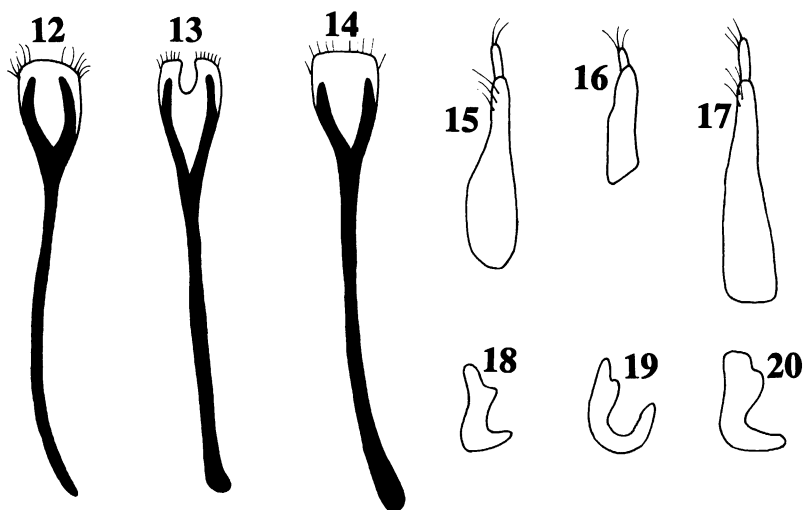

Figs. 12–20. Female genitalia. 12–14, Female sternum 8; 15–17, hemisternites; 18–20, spermatheca; 12, 15, 18, *M. bilbo*; 13, 16, 19, *M. coelorum*; 14, 17, 20, *M. frodo*.

***Macrostyphlus frodo*, new species**

Figures 14, 17, 20

DIAGNOSIS: This species is recognized by the following characters: elytral setae straight or slightly curved, blunt; tibiae not mucronate; and spermathecal ramus short.

DESCRIPTION: Holotype female. Body vestiture of subcircular scales and setae. Eyes medium-sized (as long as rostrum height). Scrobes subtriangular; suprascrobal keel fine. Antenna with scape inflated, exceeding hind margin of eye when resting in scrobe; funicular articles 3–6 monilliform. *Pronotum* with apical impression poorly developed; median carina, sulcus, and lateral impressions absent; densely squamose. Scutellum slightly prominent. *Elytra* with flat intervals; not tuberculate; base of interval 3 prominent; setae strong, straight or slightly curved, blunt. *Sternites* lacking scales. *Legs* with tibiae not mucronate; with one spur each. *Body length* 2.8 mm.

Female Genitalia: Sternum 8 (fig. 14) with very long apodeme ($2.9\times$ longer than plate); plate with entire apex, with long setae; arms long, reaching apex. Hemisternites (fig. 17) elongate, $5.0\times$ longer than wide. Spermatheca (fig. 20) with short ramus.

Male: Unknown.

GEOGRAPHICAL DISTRIBUTION: Known from central Colombia (fig. 11).

TYPE MATERIAL: Holotype female with the following labels: [COLOMBIA: Páramo/Chisacal, 3000 ft./ 4 October 1966/ SS & WD Duckworth] [*Macrostyphlus/ frodo* Morrone/ holotype female] (USNM). One paratype with the following labels: [COLOMBIA. Bogotá: Monserrate/ 3200 m, soil 0–5 cm, Sturm/ coll., 22-II-1968] [*Macrostyphlus/ frodo* Morrone/ paratype] (ICNB).

ETYMOLOGY: The name of this species, a noun in apposition, is based upon Frodo, from Tolkien's *The Lord of the Rings*.

***Macrostyphlus gandalf*, new species**

Figures 21–25

DIAGNOSIS: This species is recognized by the pronotum with two subcircular, lateral impressions.

DESCRIPTION: Holotype male. Body vestiture of subcircular scales and setae. Eyes small (as long as half of rostrum height). Scrobes subtriangular; suprascrobal keel fine. Antenna with scape gradually widening toward apex, reaching hind margin of eye when resting in scrobe; funicular articles 3–6 monilliform. *Pronotum* lacking apical impression, median carina, and median sulcus; with two subcir-

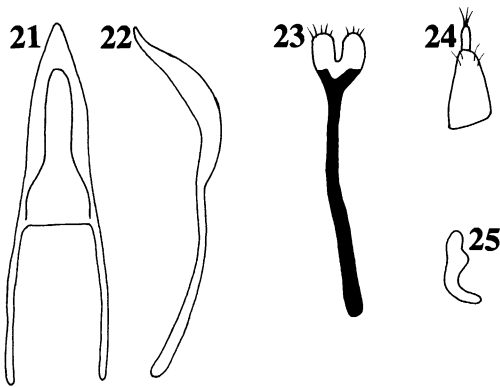

Figs. 21–25. *Macrostyphlus gandalf*, male and female genitalia. 21, Aedeagus, dorsal view; 22, aedeagus, lateral view; 23, female sternum 8; 24, hemisternites; 25, spermatheca.

cular, lateral impressions; densely squamose. Scutellum not prominent. *Elytra* with slightly convex intervals; with small tubercles; base of interval 3 flat; setae slender, curved, tapered. *Sternites* lacking scales. *Legs* with tibiae mucronate; lacking spurs. *Body length* 1.9 mm.

Male Genitalia: Aedeagus (figs. 21, 22) with pointed apex.

Female Genitalia: Sternum 8 (fig. 23) with very long apodeme ($3.7\times$ longer than plate); plate with open apex, with long setae; arms short, not reaching apex. Hemisternites (fig. 24) subtriangular, $2.0\times$ longer than wide. Spermatheca (fig. 25) with enlarged ramus.

GEOGRAPHICAL DISTRIBUTION: Known only from the type locality in southwestern Colombia (fig. 11).

TYPE MATERIAL: Holotype male with the following labels: [COLOM., 20 Km E/ Silvia, Cauca, VII./ 16.1970, 12,000'fv J. M. Campbell] [CANADIAN NATIONAL/ COLLECTION-AGRICULTURE/ CANADA, OTTAWA] [*Macrostyphlus/ gandalf* Morrone/ holotype male] (CNCI). Four paratypes with the same labels (1 CMN, 2 CNCI, 1 MLP). Two paratypes with the following labels: [COLOM., 25 Km. E/ Silvia, Cauca, VII./ 16.1970, 11,000'/ J. M. Campbell] [CANADIAN NATIONAL/ COLLECTION-AGRICULTURE/ CANADA, OTTAWA] [*Macrostyphlus/ gandalf* Morrone/ paratype] (1 CMN, 1 CNCI).

ETYMOLOGY: The name of this species, a noun in apposition, is based upon Gandalf, from Tolkien's *The Lord of the Rings*.

Macrostyphlus gualcalae Kirsch

Macrostyphlus gualcalae Kirsch, 1889: 25; Schenkling and Marshall, 1931: 4 (cat.); Blackwelder, 1947: 814 (checklist); Wibmer and O'Brien, 1986: 117 (checklist).

DIAGNOSIS: This species is recognized by the combination of scape reaching hind margin of eye when resting in scrobe, and elytral setae straight, blunt.

REDESCRIPTION: Holotype male. Body vestiture of subcircular scales and setae. Eyes medium-sized (as long as rostrum height). Scrobes subtriangular; suprascrobal keel fine. Antenna with scape inflated, reaching hind margin of eye when resting in scrobe; funicular articles 3–6 monilliform. *Pronotum* lacking median carina, sulcus, and impressions; densely squamose. Scutellum not prominent. *Elytra* with flat intervals; not tuberculate; base of interval 3 prominent; setae strong, straight, blunt. *Sternites* lacking scales. *Legs* with tibiae mucronate; with two spurs each. *Body length* 3.1 mm.

Male Genitalia: Not dissected.

Female: Unknown.

GEOGRAPHICAL DISTRIBUTION: Known only from the type locality in southwestern Colombia (fig. 11).

TYPE MATERIAL: Holotype male with the following labels: [Colombia/ Tuquerres/ 3815] [Type] [Staatl. Museum für/ Tierkunde Dresden] [*Macrostyphlus/ gualcalae* Kirsch] (SMTD).

Macrostyphlus howdenorum,
new species

Figures 26, 28, 30

DIAGNOSIS: This species is recognized by the combination of the following characters: suprascrobal keel strong; scape gradually widening toward apex; elytral intervals convex; sternites squamose; and tibiae with two spurs and mucronate.

DESCRIPTION: Holotype female. Body vestiture of subcircular scales and setae. Eyes medium-sized (as long as rostrum height). Scrobes subtriangular; suprascrobal keel strong. Antenna with scape gradually wid-

ening toward apex, exceeding hind margin of eye when resting in scrobe; funicular articles 3–6 monilliform. *Pronotum* with apical impression well developed; median carina, lacking sulcus and lateral impressions absent; densely squamose. Scutellum slightly prominent. *Elytra* with slightly convex intervals; not tuberculate; base of interval 3 prominent; setae slender, curved, tapered. *Sternites* squamose. *Legs* with tibiae not mucronate; with two spurs each. *Body length* 2.6 mm.

Female Genitalia: Sternum 8 (fig. 26) with very long apodeme ($2.5\times$ longer than plate); plate with entire apex, with long setae; arms long, reaching apex. Hemisternites (fig. 28) elongate, $5.2\times$ longer than wide. Spermatheca (fig. 30) with enlarged ramus.

Male: Unknown.

GEOGRAPHICAL DISTRIBUTION: Known only from the type locality in northern Ecuador (fig. 11).

TYPE MATERIAL: Holotype female with the following labels: [ECUADOR, Napo/ Quito-Baeza Rd./ III 83 4100 m/ L/ Masner pan tr.] [H. & A. Howden/ Collection] [*Macrostyphlus/ howdenorum* Morrone/ holotype female] (HAHC). One paratype with the same data (HAHC).

ETYMOLOGY: I name this species after the specialists Henry and Anne Howden, whose advice and hospitality I greatly appreciate.

Macrostyphlus peruvianus,
new species

Figures 27, 29, 31

DIAGNOSIS: This species is recognized by the combination of the following characters: body vestiture consisting of setalike scales; eyes medium-sized (as long as rostrum height); and apodeme of female sternum 8 long.

DESCRIPTION: Holotype female. Body vestiture of setalike scales and setae. Eyes medium-sized (as long as rostrum height). Scrobes subtriangular; suprascrobal keel fine. Antenna with scape gradually widening toward apex, exceeding hind margin of eye when resting in scrobe; funicular articles 3–6 monilliform. *Pronotum* lacking apical impression, median carina, sulcus, and lateral impressions; sparsely squamose. Scutellum not prominent. *Elytra* with flat intervals; not tuberculate; base of interval 3 flat; setae strong,

curved, tapered. *Sternites* lacking scales. *Legs* with tibiae mucronate; with one spur each. *Body length* 3.4 mm.

Female Genitalia: Sternum 8 (fig. 27) with long apodeme ($1.4\times$ longer than plate); plate with sinuate apex, with long setae; arms long, reaching apex. Hemisternites (fig. 29) subtriangular, $2.4\times$ longer than wide. Spermatheca (fig. 31) with enlarged ramus.

Male: Unknown.

GEOGRAPHICAL DISTRIBUTION: Known only from the type locality in southern Peru (fig. 11).

TYPE MATERIAL: Holotype female with the following labels: [PERU: Cuzco Dept./ Píllahuata. Manu rd/ km. 128, 21.IX.1982/ L. Watrous & G. Mazurek/ litter & moss-xeric slope] [FIELD MUSEUM OF/ NATURAL HISTORY/ CHICAGO, IL. USA] [*Macrostyphlus/ peruvianus* Morrone/ holotype female] (FMNH).

ETYMOLOGY: This species is named after the country of Peru.

Macrostyphlus sturmi,
new species
Figures 32, 33

DIAGNOSIS: This species is recognized by the transverse funicular articles 3–6. In addition, the combination of a pronotal median carina and elytra with small tubercles is diagnostic.

DESCRIPTION: Holotype male. Body vestiture of subcircular scales and setae. Eyes medium-sized (as long as rostrum height). Scrobes subtriangular; suprascrobal keel fine. Antenna with scape inflated, reaching hind margin of eye when resting in scrobe; funicular articles 3–6 transverse. *Pronotum* lacking sulcus and impressions; median carina present; densely squamose. Scutellum prominent. *Elytra* with slightly convex intervals; with small tubercles; base of interval 3 prominent; setae strong, curved, tapered. *Sternites* lacking scales. *Legs* with tibiae mucronate; with one spur each. *Body length* 2.4 mm.

Male Genitalia: Aedeagus (figs. 32, 33) with rounded apex.

Female: Unknown.

GEOGRAPHICAL DISTRIBUTION: Known only from the type locality in central Colombia (fig. 11).

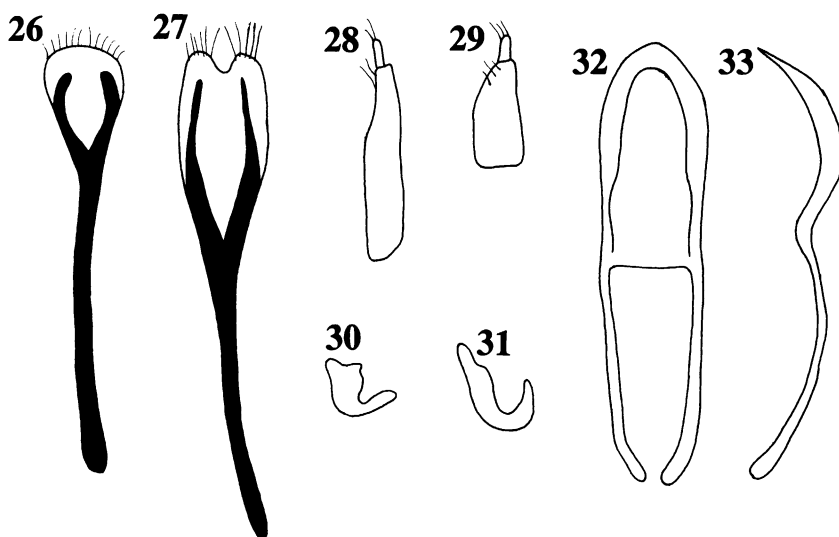

Figs. 26–33. Male and female genitalia. 26, 27, Female sternum 8; 28, 29, hemisternites; 30, 31, spermatheca; 32, aedeagus, dorsal view; 33, aedeagus, alteral view; 26, 28, 30, *M. howdenorum*; 27, 29, 31, *M. peruvianus*; 32, 33, *M. sturmi*.

TYPE MATERIAL: Holotype male with the following labels: [COLOMBIA. Bogotá: Monserrate, / 3200 m, grass tuft, Sturm coll., 22-II-1968] [*Macrostyphlus sturmi* Morrone / holotype male] (ICNB). One paratype with the same data (ICNB).

ETYMOLOGY: I name this species after the specialist Helmut Sturm, who collected the specimens upon which it is described, and who made them available to me.

Macrostyphlus transatlanticus
(Kirsch)

Rhytirhinus transatlanticus Kirsch, 1889: 24; Hustache, 1930: 271; Schenkling and Marshall, 1931: 17 (cat.); Blackwelder, 1947: 814 (checklist).

Puranius transatlanticus; Kuschel, 1955: 290.

Macrostyphlus transatlanticus; Kuschel, 1986: 118; Wibmer and O'Brien, 1986: 118 (checklist).

DIAGNOSIS: The following combination of characters is diagnostic: pronotum with median carina; base of elytral interval 3 tuberculate; elytral setae slender; sternites squamose; and plate of female sternum 8 entire.

REDESCRIPTION: Holotype male. Body vestiture of subcircular scales and setae. Eyes medium-sized (as long as rostrum height). Scrobes subtriangular; suprascrobal keel fine. Antenna with scape inflated, reaching hind

margin of eye when resting in scrobe; funicular articles 3–6 monilliform. *Pronotum* with apical impression; median carina, median sulcus, and lateral impressions absent; densely squamose. *Scutellum* prominent. *Elytra* with slightly convex intervals; with small tubercles; base of interval 3 flat; setae strong, curved, tapered. *Sternites* squamose. *Legs* with tibiae mucronate; with one spur each. *Body length* 3.5 mm.

Male Genitalia: Not dissected.

Female: Unknown.

GEOGRAPHICAL DISTRIBUTION: Known from northern Ecuador (fig. 11).

TYPE MATERIAL: Holotype male with the following labels: [5812] Ecuador / Antisana] [6288] [Typus] [Staatl. Museum für Tierkunde, Dresden] [*transatlan-* / *ticus*] (SMTD).

Macrostyphlus venezolanus,
new species

Figures 1, 34–38

DIAGNOSIS: This species is recognized by the pronotum with median sulcus.

DESCRIPTION: Holotype male. Body vestiture of subcircular scales and setae. Eyes medium-sized (as long as rostrum height). Scrobes subtriangular; suprascrobal keel fine. Antenna with scape inflated, reaching hind

margin of eye when resting in scrobe; funicular articles 3–6 monilliform. *Pronotum* (fig. 1) with apical impression poorly developed; sulcus present; median carina and lateral impressions absent; densely squamose. Scutellum not prominent. *Elytra* (fig. 1) with slightly convex intervals; not tuberculate; base of interval 3 prominent; setae strong, curved, tapered. *Sternites* squamose. *Legs* with tibiae mucronate; lacking spurs. *Body length* 2.4 mm.

Male Genitalia: Aedeagus (figs. 34, 35) with rounded apex.

Female Genitalia: Sternum 8 (fig. 36) with very long apodeme (1.9 × longer than plate); plate with open apex, with long setae; arms long, reaching apex. Hemisternites (fig. 37) elongate, 3.0 × longer than wide. Spermatheca (fig. 38) with short ramus.

GEOGRAPHICAL DISTRIBUTION: This is the first Rhytirrhini described from Venezuela (fig. 11).

TYPE MATERIAL: Holotype male with the following labels: [VENEZUELA: MERIDA/ Mérida, Telef. Est. La/ Aguada, 3460 m, 23.VI.1989, / S. & J. Peck, tree line/ moss forest litter] [CANADIAN MUSEUM/ OF NATURE INSECT/ COLLECTION] [*Macrostyphlus venezolanus* Morrone/ holotype male] (CMN). One paratype with the same data (CMN). One paratype with the following labels: [VEN: Merida, Apartaderos/ Laguna Mucubaji, 29.VII/ 89, 3500 m, páramo/ cushion plant litter] [CANADIAN MUSEUM/ OF NATURE INSECT/ COLLECTION] [*Macrostyphlus venezolanus* Morrone/ paratype] (CMN). One paratype with the following labels: [VEN: Mérida, Mérida/ Telef. Est. La Aguada/ 28.VI.89, 3450 m/ *Espeletia* leaf bases/ páramo, S&J Peck] [CANADIAN MUSEUM/ OF NATURE INSECT/ COLLECTION] [*Macrostyphlus venezolanus* Morrone/ paratype] (MLP).

ETYMOLOGY: The name of this species is based after the country of Venezuela.

Adioristidius Voss

Type species: *Adioristus similaris* Voss, 1954 (here designated).

Adioristidius Voss, 1954: 242 (subgenus of *Adioristus*, not available, type species not fixed); Kuschel, 1986: 116 (= *Macrostyphlus*).

Anchadioristus Voss, 1954: 242 (subgenus of

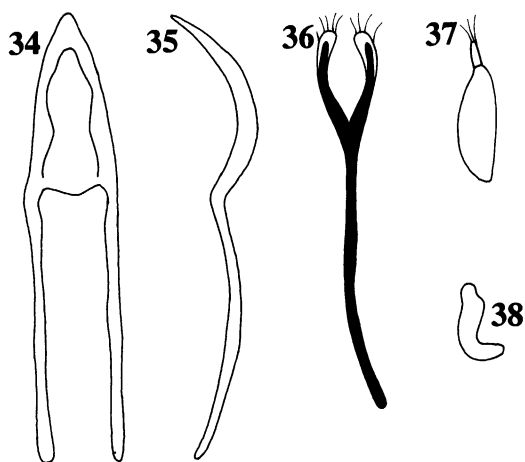

Figs. 34–38. *Macrostyphlus venezolanus*, male and female genitalia. 34, Aedeagus, dorsal view; 35, aedeagus, lateral view; 36, female sternum 8; 37, hemisternites; 38, spermatheca.

Adioristus, not available, type species not fixed); Kuschel, 1986: 116 (= *Macrostyphlus*). New synonym.

Voss (1954) described *Adioristidius* and *Anchadioristus*, as subgenera of *Adioristus*. In *Anchadioristus* he placed *A. tuberculatus* and *A. subtuberculatus* (although he keyed the latter in both subgenera); only *A. tuberculatus* was available for study. The cladistic analysis clearly shows that it is simply a member of *Adioristidius*, so both generic names are treated as synonyms.

DIAGNOSIS: The species of this genus are recognized by the ovate antennal club and the subcircular pronotum.

REDESCRIPTION: Very small to small (body length 1.5–4.1 mm). Integument rugose, dark brown. Body vestiture usually of setalike scales and setae; some species with subcircular scales or lacking them. Frons with fovea or lacking it. Eyes very small (shorter than half of rostrum height) to medium-sized (as long as rostrum height), flat; supraocular sulcus usually absent. Rostrum with three dorsal keels, or lacking them; usually lacking scales. Antenna with funicular articles 3–6 monilliform; club ovate. *Pronotum* (fig. 2) subcircular; usually not tuberculate; postocular lobes usually poorly developed. Metepisternal suture usually absent. Scutellum prominent or not. *Elytra* (fig. 2) ovate, with rounded humeri; setae usually simple, curved, tapered.

Legs with tibiae usually mucronate; with 1–2 spurs or lacking them; usually not squamose.

Male Genitalia: Aedeagus with apex variable in shape; apodemes usually slightly longer than tube.

Female Genitalia: Sternum 8 with apodeme usually long (fig. 41); plate subcircular (fig. 40) or subelliptical (fig. 41), sclerotized arms usually long, reaching apex. Hemisternites elongate (fig. 43); with baculi; styli present. Spermatheca with enlarged ramus (fig. 44); nodulus present (fig. 44) or absent (fig. 60).

BIOLOGY: *Adioristidius manu* has been found in leaf litter. Some species have been associated with *Mulinum* sp. [Apiaceae] (*A. chilensis*), *Stipa* sp. [Poaceae] (*A. jorgei*), and *Solanum tuberosum* [Solanaceae] (*A. tuberculatus*).

Cladistics. The following characters were analyzed:

1. FRONS. [0] with fovea; [1] lacking fovea.
2. EYES. [0] medium-sized (as long as rostrum height); [1] small (as long as half of rostrum height); [2] very small (shorter than half of rostrum height).
3. SUPRAOCULAR SULCUS. [0] absent; [1] present.
4. ROSTRUM. [0] lacking scales; [1] squamose.
5. ROSTRAL DORSAL KEELS. [0] present, strong; [1] present, slender; [2] absent.
6. SCROBES. [0] linear; [1] subtriangular.
7. SUPRASCROBAL KEEL. [0] absent; [1] present, fine; [2] present, strong.
8. SCAPE. [0] exceeding hind margin of eye when resting in scrobe; [1] reaching hind margin of eye when resting in scrobe; [2] not reaching eye when resting in scrobe.
9. SCAPE. [0] gradually widening toward apex; [1] inflated.
10. PRONOTAL APICAL IMPRESSION. [0] well developed; [1] poorly developed; [2] absent.
11. PRONOTAL MEDIAN CARINA. [0] absent; [1] present.
12. PRONOTAL MEDIAN SULCUS. [0] absent; [1] present.
13. PRONOTUM. [0] not tuberculate; [1] tuberculate.
14. METEPISTERNAL SUTURE. [0] present; [1] absent.
15. BASE OF ELYTRAL INTERVAL 3. [0] flat; [1] slightly prominent.
16. ELYTRA. [0] not tuberculate; [1] with small tubercles.
17. ELYTRAL INTERVALS. [0] flat; [1] slightly convex; [2] strongly convex.
18. ELYTRAL SETAE. [0] slender; [1] strong.
19. ELYTRAL SETAE. [0] simple; [1] bifid; [2] multifid.
20. SCALES. [0] subcircular; [1] setalike; [2] absent.
21. LEGS. [0] lacking scales; [1] squamose.
22. PROTIBIAL MUCRO. [0] present; [1] absent.
23. MESOTIBIAL MUCRO. [0] present; [1] absent.
24. METATIBIAL MUCRO. [0] present; [1] absent.
25. PROTIBIAL SPURS. [0] two; [1] one; [2] absent.
26. MESOTIBIAL SPURS. [0] two; [1] one; [2] absent.
27. METATIBIAL SPURS. [0] two; [1] one; [2] absent.
28. AEDEAGAL APODEMES. [0] slightly longer than tube (figs. 48, 49); [1] more than twice longer than tube (figs. 46, 47).
29. APODEME OF FEMALE STERNUM 8. [0] short; [1] long (fig. 41); [2] very long (fig. 56).
30. PLATE OF FEMALE STERNUM 8. [0] sinuate (fig. 64); [1] entire (fig. 69); [2] open (fig. 57).
31. ARMS OF FEMALE STERNUM 8. [0] long, reaching apex (fig. 41); [1] short, not reaching apex (fig. 64).
32. SPERMATHECAL NODULUS. [0] present (fig. 77); [1] absent (fig. 66).

The analysis of the data matrix (table 4) led to one cladogram, with 104 steps, a consistency index of 0.43, and a retention index of 0.47 (fig. 39). The cladogram has a basal trichotomy for *A. puncticollis* and two major clades. One clade includes *A. crassirostris*, *A. chilensis*, *A. jorgei* plus *A. hirsutus*, and *A. similis* plus *A. variegatus*. The other clade includes *A. granulatus* plus *A. morio*, *A. manu*, *A. tuberculatus*, *A. sulcicollis*, *A. hysdanus*, *A. costulatus*, *A. anchonoideus*, *A. lidiae*, and *A. nivalis*.

TABLE 4
Data Matrix for *Adioristidius* Voss

	1									2									3													
	1	2	3	4	5	6	7	8	9	0	1	2	3	4	5	6	7	8	9	0	1	2	3	4	5	6	7	8	9	0	1	2
<i>Listroderes</i>	0	0	0	0	0	0	0	0	0	0	0	0	0	0	0	0	0	0	0	0	0	0	0	0	0	0	0	0	0	0	0	0
<i>A. anchonoideus</i>	0	1	0	0	1	0	1	1	1	2	0	0	0	1	0	0	1	1	0	0	0	1	0	0	0	1	0	0	2	1	1	?
<i>A. chilensis</i>	1	0	0	0	1	1	1	0	1	1	0	0	0	0	0	0	0	0	0	0	0	0	1	0	0	0	2	2	0	0	1	?
<i>A. costulatus</i>	1	1	0	0	1	0	1	2	1	1	0	0	0	1	0	0	1	0	0	0	0	1	0	0	2	0	0	0	0	0	?	1
<i>A. crassirostris</i>	1	0	0	1	1	1	0	2	1	2	0	0	0	1	0	0	0	0	0	0	1	0	0	0	0	0	0	0	0	?	?	?
<i>A. granulatus</i>	1	1	0	0	2	1	1	1	0	2	0	0	0	1	0	0	0	0	0	0	0	0	0	0	0	0	1	1	0	0	0	?
<i>A. jorgei</i>	1	1	0	0	2	1	2	0	1	2	0	0	0	1	0	0	0	0	0	0	1	0	0	0	0	0	2	0	0	?	?	?
<i>A. hirsutus</i>	1	1	0	0	2	1	2	0	1	2	0	0	0	0	0	0	0	0	0	0	1	0	0	0	0	0	0	1	0	?	?	?
<i>A. hydanius</i>	0	1	0	1	1	0	1	1	0	1	0	1	1	1	1	2	1	0	0	1	0	0	0	0	0	0	0	0	0	?	2	1
<i>A. lidiae</i>	1	1	0	0	2	0	1	1	1	1	0	0	0	1	0	0	0	1	2	0	0	0	1	2	0	0	0	1	1	?	1	2
<i>A. manu</i>	0	1	0	1	1	1	1	1	1	1	0	0	0	1	0	1	1	0	0	1	0	0	0	0	0	0	0	0	0	2	0	1
<i>A. morio</i>	0	2	0	0	1	1	1	0	0	2	0	0	0	1	0	0	0	0	0	2	0	1	1	1	0	0	0	1	?	?	?	?
<i>A. nivalis</i>	0	1	0	0	2	1	2	1	1	1	0	0	0	1	0	0	0	0	0	0	0	0	0	0	0	1	1	2	2	1	?	1
<i>A. puncticollis</i>	0	0	1	0	1	1	1	1	1	2	0	0	0	1	0	0	0	0	0	2	0	0	0	0	0	0	0	0	?	1	2	0
<i>A. similis</i>	1	1	0	0	2	1	0	0	1	0	0	0	0	1	0	0	0	0	0	1	0	1	1	0	2	2	2	?	?	?	?	?
<i>A. sulcicollis</i>	0	0	0	0	1	0	0	0	1	1	0	1	1	1	1	1	1	2	0	1	0	0	0	0	0	0	0	0	?	2	1	0
<i>A. tuberculatus</i>	1	1	1	0	0	1	2	1	1	0	1	0	1	0	1	0	0	1	1	1	1	1	1	0	0	0	0	2	2	0	1	1
<i>A. variegatus</i>	1	1	0	0	2	1	0	0	1	2	0	0	0	1	0	0	0	0	0	1	0	0	0	0	2	2	2	?	?	?	?	?

GEOGRAPHICAL DISTRIBUTION: The majority of the species of *Adioristidius* are distributed in Bolivia and southern Peru, in the Punan biogeographic province of the Andeanpatagonian dominion of Cabrera and Willink (1973). Four species extend the range to Chile: *A. nivalis* (Desert province, Andeanpatagonian dominion), *A. jorgei* (Central Chilean province, Andeanpatagonian dominion), and *A. chilensis* and *A. hirsutus* (Subantarctic province, Subantarctic dominion) (figs. 50, 55, 83). It must be pointed out that because the type specimens of some species described by Hustache (1938a, b) or Voss (1954) have no specific localities, just "Bolivia" or "Peru," it is difficult to infer anything about their distribution. Biogeographical patterns of this genus are analyzed under "Geographical distribution" of *Puranius*.

KEY TO THE SPECIES OF *ADIORISTIDIUS* VOSS

- 1. Body vestiture of scales and setae 2
- 1a. Body vestiture lacking scales, only with setae 14
- 2. Metepisternal suture present 3
- 2a. Metepisternal suture absent 5
- 3. Rostrum lacking dorsal keels; pronotum lacking apical impression; mesotibiae with

- one spur; < 3.0 mm body length; central Chile *A. hirsutus*, n. sp.
- 3a. Rostrum with three dorsal keels; pronotum with apical impression; mesotibiae lacking spurs; > 3.1 mm body length 4
- 4. Supraocular sulcus absent; scape exceeding hind margin of eye when resting in scrobe; pronotum lacking median carina; elytral setae simple, slender, curved, tapered; protibiae lacking spurs; apex of aedeagus lacking hairs; central Chile *A. chilensis*, n. sp.
- 4a. Supraocular sulcus present; scape reaching hind margin of eye when resting in scrobe; pronotum with median carina; elytral setae bifid, strong, straight, blunt; protibiae with one spur; apex of aedeagus with hairs; Bolivia and Peru *A. tuberculatus* (Voss)
- 5. Scales of pronotum and elytra subcircular 6
- 5a. Scales of pronotum and elytra setalike 10
- 6. Rostrum and legs squamose; pronotum with median sulcus 7
- 6a. Rostrum and legs lacking scales; pronotum lacking median sulcus 8
- 7. Scape inflated, exceeding hind margin of eye when resting in scrobe; pronotum sparsely squamose, with deep median sulcus; elytral setae multifid; > 2.0 mm body length; Bolivia *A. sulcicollis* (Hustache)
- 7a. Scape gradually widening toward apex, reaching hind margin of eye when resting

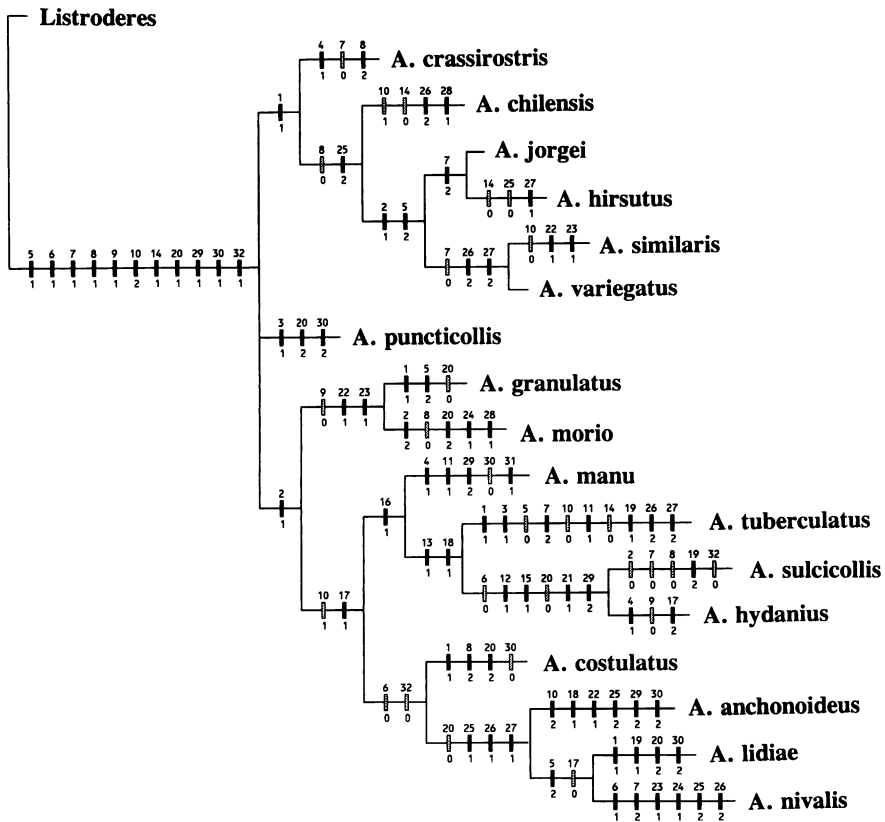

Fig. 39. Cladogram of species of the genus *Adioristidius*.

- in scrobe; pronotum densely squamose, with poorly developed median sulcus; elytral setae simple; < 1.9 mm body length; Bolivia *A. hydanius*, n. sp.
- 8. Suprascrobal keel strongly developed; pronotum with two subcircular, lateral impressions; protibiae mucronate; mesotibiae lacking spurs; northern Chile *A. nivalis* (Kuschel)
- 8a. Suprascrobal keel fine; pronotum lacking lateral impressions; protibiae lacking mucro; mesotibiae with 1-2 spurs 9
- 9. Frons lacking fovea; scrobes subtriangular; scape gradually widening toward apex; pronotum with well-developed postocular lobes; elytral setae slender, curved, tapered; all tibiae with one spur; < 2.0 mm body length; Bolivia *A. granulatus* (Hustache)
- 9a. Frons with fovea; scrobes linear; scape inflated; pronotum lacking postocular lobes; elytral setae strong, straight, blunt; protibiae lacking spurs, and meso- and metatibiae with two spurs; > 2.1 mm body length; Bolivia *A. anchonoideus* (Hustache)
- 10. Rostrum lacking dorsal keels; scape exceeding hind margin of eye when resting in scrobe 11
- 10a. Rostrum with three dorsal keels; scape not reaching hind margin of eye when resting in scrobe 13
- 11. Suprascrobal keel present; all tibiae with one spur; < 3.0 mm body length; central Chile *A. jorgei*, n. sp.
- 11a. Suprascrobal keel absent; all tibiae lacking spurs; > 3.1 mm body length 12
- 12. Pronotum with apical impression and well-developed postocular lobes; pro- and mesotibiae lacking mucro; Peru *A. similis* (Voss)
- 12a. Pronotum lacking apical impression and postocular lobes; pro- and mesotibiae mucronate; Bolivia *A. variegatus* (Voss)

13. Frons lacking fovea; rostrum squamose; suprascrobal keel absent; pronotum lacking median carina and apical impression; Bolivia *A. crassirostris* (Hustache)
- 13a. Frons with fovea; rostrum lacking scales; suprascrobal keel present; pronotum with median carina and poorly developed apical impression; Peru . . . *A. manu*, n. sp.
14. Pronotum with apical impression; scutellum slightly prominent; elytral intervals slightly convex; Bolivia
. *A. costulatus* (Hustache)
- 14a. Pronotum lacking apical impression; scutellum not prominent; elytral intervals flat 15
15. Elytral setae bifid; pro- and mesotibiae with two spurs; Bolivia. *A. lidiae*, n. sp.
- 15a. Elytral setae simple; pro- and mesotibiae with one spur or lacking it 16
16. Eyes very small (shorter than half of rostrum height); supraocular sulcus absent; scape gradually widening toward apex, exceeding hind margin of eye when resting in scrobe; tibiae lacking mucro; < 2.5 mm body length; Peru *A. morio* (Voss)
- 16a. Eyes medium-sized (as long as rostrum height); supraocular sulcus present; scape inflated, reaching hind margin of eye when resting in scrobe; tibiae mucronate; > 2.6 mm body length; Bolivia
. *A. puncticollis* (Hustache)

Adioristidius anchonoideus
(Hustache), new combination
Figures 40, 42, 44

- Hyperodes anchonoideus* Hustache, 1938a: 181; Blackwelder, 1947: 814 (checklist).
- Amathynetes anchonoideus*; Kuschel, 1949: 45.
- Puranius anchonoideus*; Kuschel, 1955: 288.
- Listronotus anchonoideus*; O'Brien, 1979: 267.
- Macrostyphlus anchonoideus*; Kuschel, 1986: 116; Wibmer and O'Brien, 1986: 116 (checklist).

DIAGNOSIS: This species is recognized by the combination of the following characters: body vestiture of subcircular scales; frons with fovea; scrobes linear; elytral intervals slightly convex; and protibiae lacking mucro.

REDESCRIPTION: Body vestiture of subcircular scales and setae. Frons with fovea. Eyes small (as long as half of rostrum height); supraocular sulcus absent. Rostrum with three slender, dorsal keels; lacking scales. Scrobes linear; suprascrobal keel fine. Antenna with scape inflated; reaching hind margin of eye when resting in scrobe. *Pronotum* lacking api-

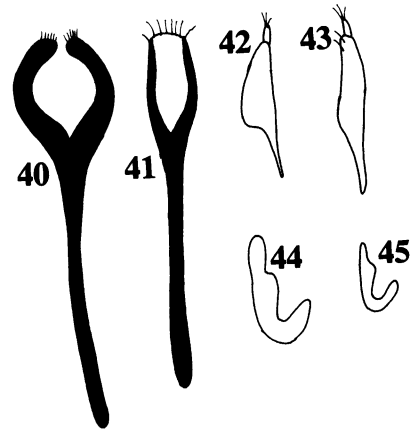

Figs. 40–45. Female genitalia. 40, 41, Female sternum 8; 42, 43, hemisternites; 44, 45, spermatheca; 40, 42, 44, *A. anchonoideus*; 41, 43, 45, *A. costulatus*.

cal impression; median carina and sulcus absent; not tuberculate; postocular lobes slightly developed. Metepisternal suture absent. Scutellum prominent. *Elytra* with slightly convex intervals; not tuberculate; base of interval 3 flat; setae simple, strong, abundant. *Legs* with protibiae lacking mucro and spurs; meso- and metatibiae mucronate and with two spurs; lacking scales. *Body length* 3.0–3.5 mm.

Female Genitalia: Sternum 8 (fig. 40) with very long apodeme (2.0 × longer than plate); plate subcircular, with open apex and short setae; arms long, reaching apex. Hemisternites (fig. 42) 4.0 × longer than wide. Spermatheca (fig. 44) with nodule.

Male: Unknown.

GEOGRAPHICAL DISTRIBUTION: Known from western Bolivia (fig. 50), in the Punan biogeographic province of Cabrera and Willink (1973).

TYPE MATERIAL: Lectotype female (here designated) with the following labels: [Bolivien/ Germain] [Coll. Kraatz] [TYPE] [Hustache/ det. 1938] [syntypus] [*Hyperodes anchonoideus*/ m./ Hustache det.] [DEI/ Eberswalde] [*Hyperodes anchonoideus* Hust.] [*Hyperodes anchonoideus* Hust./ lectotype female/ Morrone des.] (DEI). One paralectotype with the same data (DEI).

OTHER MATERIAL EXAMINED: BOLIVIA. COCHABAMBA: La Paz, Chaya, 4150 m,

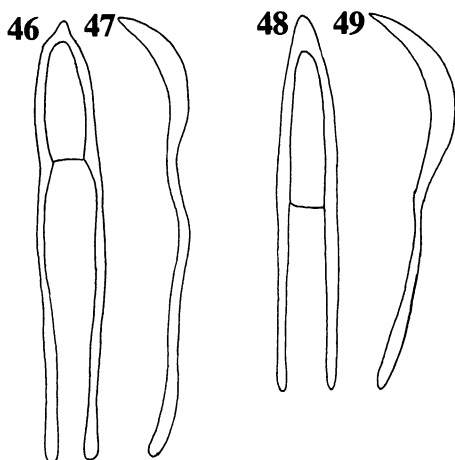

Figs. 46–49. Male genitalia. 46, 47, Aedeagus, dorsal view; 47, 49, aedeagus, lateral view; 46, 47, *A. chilensis*; 48, 49, *A. granulatus*.

24-I-1976, L. E. Peña, 1 (HAHC). ORURO: Pongo, 4200 m, 25-I-1976, L. E. Peña, 13 (11 HAHC, 2 MLP).

Adioristidius chilensis,

new species

Figures 46, 47

DIAGNOSIS: This species is recognized by the combination of the following characters: eyes medium-sized (as long as rostrum height); rostrum with three dorsal keels; metepisternal suture present; and metatibiae with one spur.

DESCRIPTION: Holotype male. Body vestiture of setalike scales and setae. Frons lacking fovea. Eyes medium-sized (as long as rostrum height); supraocular sulcus absent. Rostrum with three slender, dorsal keels; lacking scales. Scrobes subtriangular; suprascrobal keel fine. Antenna with scape inflated; exceeding hind margin of eye when resting in scrobe. *Pronotum* with apical impression poorly developed; median carina and sulcus absent; not tuberculate; postocular lobes well developed. Metepisternal suture present. Scutellum prominent. *Elytra* with flat intervals; not tuberculate; base of interval 3 flat; setae simple, slender, abundant. *Legs* with all tibiae mucronate; pro- and mesotibiae lacking spurs; metatibiae with one spur; lacking scales. *Body length* 3.5 mm.

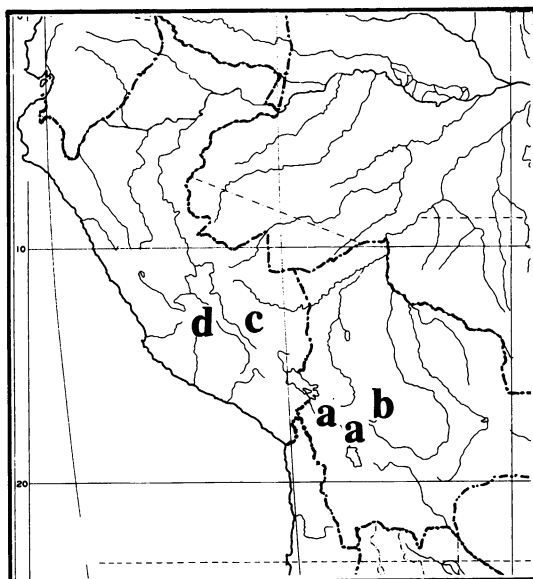

Fig. 50. Geographical distribution of the genus *Adioristidius*. a, *A. anchonoideus*; b, *A. granulatus*; c, *A. manu*; d, *A. morio*.

Male Genitalia: Aedeagus (figs. 46, 47) with produced apex; apodemes more than twice longer than tube.

Female: Unknown.

GEOGRAPHICAL DISTRIBUTION: Known only from the type locality in central Chile (fig. 55), in the Coquimban entomofaunal region of O'Brien (1971).

TYPE MATERIAL: Holotype male with the following labels: [Chile Santiago/ Lagunillas/ 10.12.1982/ Coll. M. Elgueta] [Lagunillas/ 2400-2500/ 10.12.1982/ *Mulinum*] [*Puranius*/ sp. 13] [*Adioristidius/ chilensis* Morrone/ holotype male] (MHNS).

ETYMOLOGY: This species is named after the country of Chile.

Adioristidius costulatus

(Hustache), new combination

Figures 41, 43, 45

Hyperodes costulatus Hustache, 1938a: 182; Blackwelder, 1947: 814 (checklist).

Amathynetes costulatus; Kuschel, 1949: 45.

Puranius costulatus; Kuschel, 1955: 288.

Listronotus costulatus; O'Brien, 1979: 267.

Macrostyphlus costulatus; Kuschel, 1986: 116; Wibmer and O'Brien, 1986: 116 (checklist).

DIAGNOSIS: This species is recognized by

the combination of the following characters: body vestiture lacking scales; scrobes linear; and scape not reaching hind margin of eye when resting in scrobe.

REDESCRIPTION: Body vestiture lacking scales, only with setae. Frons lacking fovea. Eyes small (as long as half of rostrum height); supraocular sulcus absent. Rostrum with three slender, dorsal keels; lacking scales. Scrobes linear; suprascrobal keel fine. Antenna with scape inflated; not reaching hind margin of eye when resting in scrobe. *Pronotum* with apical impression poorly developed; median carina and sulcus absent; not tuberculate; postocular lobes slightly developed. Metepisternal suture absent. Scutellum prominent. *Elytra* with slightly convex intervals; not tuberculate; base of interval 3 flat; setae simple, slender, abundant. *Legs* with all tibiae mucronate; with one spur; lacking scales. *Body length* 2.6 mm.

Female Genitalia: Sternum 8 (fig. 41) with long apodeme (2.1 × longer than plate); plate subelliptical, with entire apex and long setae; arms long, reaching apex. Hemisternites (fig. 43) 5.7 × longer than wide. Spermatheca (fig. 45) with nodulus.

Male: Unknown.

GEOGRAPHICAL DISTRIBUTION: Known only from the type locality, Bolivia.

TYPE MATERIAL: Lectotype female (here designated) with the following labels: [Bolivien/ Germain] [Coll. Kraatz] [TYPE] [Hustache/ det. 1938] [syntypus] [*Hyperodes/ costulatus/ m./ Hustache det.*] [DEI/ Eberswalde] [*Hyperodes/ costulatus* Hust.] [*Hyperodes costulatus/ lectotype female/ Morrone des.*] (DEI). One paralectotype, which is the holotype of *M. hydanius*, with the same data (DEI).

Adioristidius crassirostris
(Hustache), new combination

Hyperodes crassirostris Hustache, 1938a: 180; Blackwelder, 1947: 814 (checklist).

Amathynetes crassirostris; Kuschel, 1949: 45 (with doubts).

Puranius crassirostris; Kuschel, 1955: 288.

Listronotus crassirostris; O'Brien, 1979: 267.

Macrostyphlus crassirostris; Kuschel, 1986: 116; Wibmer and O'Brien, 1986: 116 (checklist).

DIAGNOSIS: This species is recognized by

the combination of the following characters: eyes medium-sized (as long as rostrum height); rostrum squamose; suprascrobal keel absent; and scape not reaching hind margin of eye when resting in scrobe.

REDESCRIPTION: Body vestiture of setalike scales and setae. Frons lacking fovea. Eyes medium-sized (as long as rostrum height); supraocular sulcus absent. Rostrum with three slender, dorsal keels; squamose. Scrobes subtriangular; suprascrobal keel absent. Antenna with scape inflated; not reaching hind margin of eye when resting in scrobe. *Pronotum* lacking apical impression; median carina and sulcus absent; not tuberculate; postocular lobes slightly developed. Metepisternal suture absent. Scutellum prominent. *Elytra* with flat intervals; not tuberculate; base of interval 3 flat; setae simple, slender, abundant. *Legs* with all tibiae mucronate; with one spur; lacking scales. *Body length* 2.6–2.8 mm.

Male and Female Genitalia: Not dissected.

GEOGRAPHICAL DISTRIBUTION: Known only from the type locality, Bolivia.

TYPE MATERIAL: Lectotype male (here designated) with the following labels: [Bolivien/ Germain] [Coll. Kraatz] [syntypus] [*Hyperodes/ crassirostris/ Hustache det.*] [DEI/ Eberswalde] [*Hyperodes/ crassirostris* Hust.] [*Hyperodes crassirostris/ lectotype male/ Morrone des.*] (DEI). One paralectotype with the same data (DEI).

Adioristidius granulatus
(Hustache), new combination
Figures 48, 49

Falklandius granulatus Hustache, 1938a: 288; Blackwelder, 1947: 814 (checklist).

Amathynetes granulatus; Kuschel, 1949: 45 (with doubts).

Puranius granulatus; Kuschel, 1955: 288.

Macrostyphlus granulatus; Kuschel, 1986: 117; Wibmer and O'Brien, 1986: 117 (checklist).

DIAGNOSIS: This species is recognized by the combination of the following characters: body vestiture of subcircular scales; scape gradually widening toward apex; and pro- and mesotibiae lacking mucro.

REDESCRIPTION: Body vestiture of subcircular scales and setae. Frons lacking fovea. Eyes small (as long as half of rostrum height); supraocular sulcus absent. Rostrum lacking

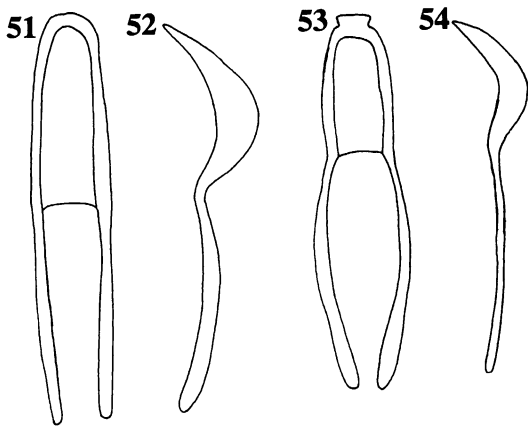

Figs. 51–54. Male genitalia. 51, 53, Aedeagus, dorsal view; 52, 54, aedeagus, lateral view; 51, 52, *A. hirsutus*; 53, 54, *A. jorgei*.

Adioristidius hirsutus,
new species
Figures 51, 52

DIAGNOSIS: This species is recognized by the very abundant setae covering the elytra. In addition, the following combination of characters is diagnostic: suprascrobal keel strongly developed; metepisternal suture present; metatibiae with two spurs; and apex of aedeagus rounded.

DESCRIPTION: Holotype male. Body vestiture of setalike scales and setae. Frons lacking fovea. Eyes small (as long as half of rostrum height); supraocular sulcus absent. Rostrum lacking dorsal keels; lacking scales. Scrobes subtriangular; suprascrobal keel strongly developed. Antenna with scape inflated; exceeding hind margin of eye when resting in scrobe. *Pronotum* lacking apical impression; median carina and sulcus absent; not tuberculate; postocular lobes slightly developed. Metepisternal suture present. Scutellum prominent. *Elytra* with flat intervals; not tuberculate; base of interval 3 flat; setae simple, slender, very abundant. *Legs* with all tibiae mucronate; pro- and mesotibiae with one spur; metatibiae with two spurs; lacking scales. *Body length* 2.6 mm.

Male Genitalia: Aedeagus (figs. 51, 52) with rounded apex; apodemes slightly longer than tube.

Female: Unknown.

GEOGRAPHICAL DISTRIBUTION: Known only from the type locality in central Chile (fig. 55), in the Coquimban entomofaunal region of O'Brien (1971).

TYPE MATERIAL: Holotype male with the following labels: [Chile Santiago/ Lagunillas/ 10.12.1982/ Coll. M. Elgueta] [CAND 24] [*Adioristidius hirsutus* Morrone/ holotype male] (MHNS). Two paratypes with the same data (1 MHNS, 1 MLP).

ETYMOLOGY: From the Latin *hirsutus* for hairy, referring to the setae covering the elytra.

Adioristidius hydanus,
new species
Figures 56, 58, 60

DIAGNOSIS: This species is recognized by the combination of the scape gradually wid-

dorsal keels; lacking scales. Scrobes subtriangular; suprascrobal keel fine. Antenna with scape gradually widening toward apex; reaching hind margin of eye when resting in scrobe. *Pronotum* lacking apical impression; median carina and sulcus absent; not tuberculate; postocular lobes well developed. Metepisternal suture absent. Scutellum prominent. *Elytra* with flat intervals; not tuberculate; base of interval 3 flat; setae simple, slender, abundant. *Legs* with pro- and mesotibiae lacking mucro, metatibiae mucronate; all tibiae with one spur; lacking scales. *Body length* 1.8–1.9 mm.

Male Genitalia: Aedeagus (figs. 48, 49) with pointed apex; apodemes slightly longer than tube.

Female: Unknown.

GEOGRAPHICAL DISTRIBUTION: Known from western Bolivia (fig. 50), in the Punan biogeographic province of Cabrera and Wilink (1973).

TYPE MATERIAL: Lectotype male (here designated) with the following labels: [Coll. Kraatz] [TYPE] [Hustache/ det. 1938] [syn-typus] [*Hyperodes granulatus* m./ Hustache det.] [DEI/ Eberswalde] [*Hyperodes granulatus* Hust.] [*Falklandius granulatus* Hust./ lectotype male/ Morrone des.] (DEI).

OTHER MATERIAL EXAMINED: BOLIVIA. COCHABAMBA: 55 mi SW Cochabamba, 5-IV-1978, 4 (CWOB).

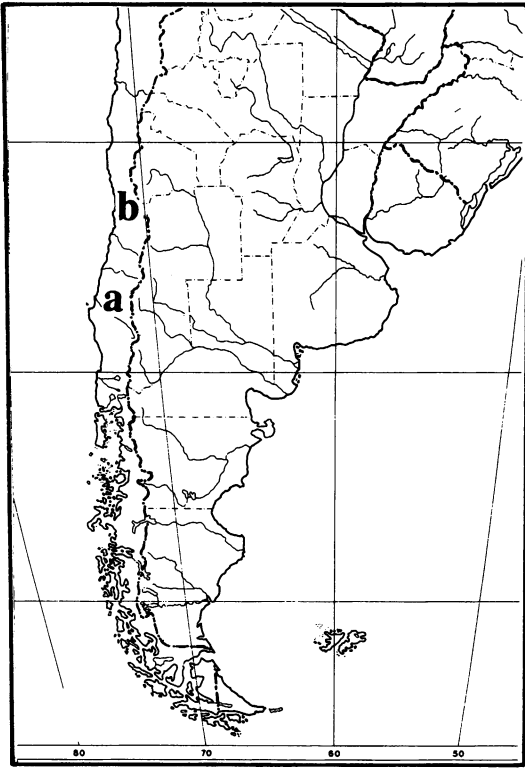
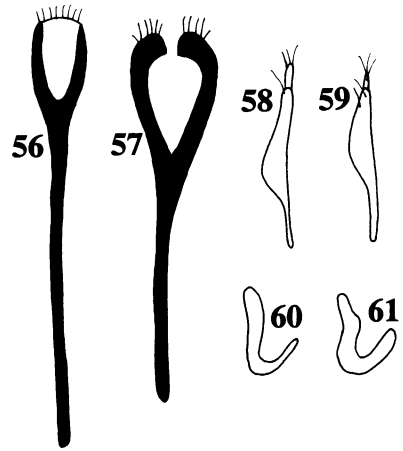

Fig. 55. Geographical distribution of the genus *Adioristidius*. a, *A. chilensis* and *A. hirsutus*; b, *A. jorgei*.

ening toward apex, and the strongly convex elytral intervals.

DESCRIPTION: Holotype female. Body vestiture of subcircular scales and setae. Frons with fovea. Eyes small (as long as half of rostrum height); supraocular sulcus absent. Rostrum with three slender, dorsal keels; squamose. Scrobes linear; suprascrobal keel fine. Antenna with scape gradually widening toward apex; reaching hind margin of eye when resting in scrobe. *Pronotum* with apical impression poorly developed; median sulcus present; median carina absent; with small tubercles; postocular lobes well developed. Metepisternal suture absent. Scutellum not prominent. *Elytra* with strongly convex intervals; with small tubercles; base of interval 3 slightly prominent; setae simple, strong, abundant. *Legs* with all tibiae mucronate; with one spur; lacking scales. *Body length* 1.5 mm.



Figs. 56–61. Female genitalia. 56, 57, Female sternum 8; 58, 59, hemisternites; 60, 61, spermatheca; 56, 58, 60, *A. hydanus*; 57, 59, 61, *A. lidiae*.

Female Genitalia: Sternum 8 (fig. 56) with very long apodeme ($3.0 \times$ longer than plate); plate subelliptical, with entire apex and long setae; arms long, reaching apex. Hemisternites (fig. 58) $6.6 \times$ longer than wide. Spermatheca (fig. 60) lacking nodulus.

Male: Unknown.

GEOGRAPHICAL DISTRIBUTION: Known only from the type locality, Bolivia.

TYPE MATERIAL: Holotype female with the following labels: [Bolivien/ Germain] [Coll. Kraatz] [Hustache det.] [? *Hyperodes/ costulatus/ m.*] [Dtsch. Entomol./ Institut Berlin/ 1427] [Syntypus] [*Adioristidius/ hydanus* Morrone/ holotype female] (DEI). The holotype is also a paralectotype of *A. costulatus* (Hustache).

ETYMOLOGY: From the Anglo-Saxon *hydan* for hidden, referring to the fact that the holotype was “hidden” within the type series of *A. costulatus*.

***Adioristidius jorgei*,**
new species
Figures 53, 54

DIAGNOSIS: This species is recognized by the combination of the following characters: frons lacking fovea; rostrum lacking dorsal keels; metepisternal suture absent; and apex of aedeagus straight.

DESCRIPTION: Holotype male. Body vestiture of setalike scales and setae. Frons lacking fovea. Eyes small (as long as half of rostrum height); supraocular sulcus absent. Rostrum lacking dorsal keels; lacking scales. Scrobes subtriangular; suprascrobal keel fine. Antenna with scape inflated; exceeding hind margin of eye when resting in scrobe. *Pronotum* lacking apical impression; median carina and sulcus absent; not tuberculate; postocular lobes slightly developed. Metepisternal suture absent. Scutellum not prominent. *Elytra* with flat intervals; not tuberculate; base of interval 3 flat; setae simple, slender, abundant. *Legs* with all tibiae mucronate; with one spur; lacking scales. *Body length* 2.1 mm.

Male Genitalia: Aedeagus (figs. 53, 54) with straight apex; apodemes slightly longer than tube.

Female: Unknown.

GEOGRAPHICAL DISTRIBUTION: Known only from the type locality in central Chile (fig. 55), in the Santiagan entomofaunal region of O'Brien (1971).

TYPE MATERIAL: Holotype male with the following labels: [Chile Santiago/ La Parva/ 11.03.1983/ Coll. M. Elgueta] [*Adioristidius/ jorgei* Morrone/ holotype male] (MHNS). Three paratypes with the same data (2 MHNS, 1 MLP). One paratype with the same data except 26-27.10.1981 and "bajo *Stipa*" (MHNS).

ETYMOLOGY: I name this species after my professor Jorge V. Crisci, whose continuous friendship and generous advice I greatly appreciate.

Adioristidius lidiae,

new species

Figures 57, 59, 61

DIAGNOSIS: This species is recognized by the combination of the following characters: body vestiture lacking scales; scrobes linear; scutellum not prominent; elytral setae bifid; and protibiae with two spurs.

DESCRIPTION: Holotype female. Body vestiture lacking scales, only with setae. Frons lacking fovea. Eyes small (as long as half of rostrum height); supraocular sulcus absent. Rostrum lacking dorsal keels; lacking scales. Scrobes linear; suprascrobal keel fine. Antenna

with scape inflated; reaching hind margin of eye when resting in scrobe. *Pronotum* with apical impression poorly developed; median carina and sulcus absent; not tuberculate; postocular lobes slightly developed. Metepisternal suture absent. Scutellum not prominent. *Elytra* with flat intervals; not tuberculate; base of interval 3 flat; setae bifid, slender, abundant. *Legs* with all tibiae mucronate; with two spurs; lacking scales. *Body length* 2.9 mm.

Female Genitalia: Sternum 8 (fig. 57) with long apodeme (1.5 × longer than plate); plate subcircular, with open apex and long setae; arms long, reaching apex. Hemisternites (fig. 59) 7.0 × longer than wide. Spermatheca (fig. 61) with nodulus.

Male: Unknown.

GEOGRAPHICAL DISTRIBUTION: Known only from the type locality in western Bolivia (fig. 83), in the Punan biogeographic province of Cabrera and Willink (1973).

TYPE MATERIAL: Holotype female with the following labels: [BOLIVIA: Oruro/ N. Sajama, 4000 m./ 31.xii.75, L. Peña] [H. & A. Howden/ collection] [*Adioristidius/ lidiae* Morrone/ holotype female] (HAHC). One paratype with the same data (HAHC).

ETYMOLOGY: I name this species after my mother, Lidia, in recognition of all her love, support, and encouragement.

Adioristidius manu,

new species

Figures 62-66

DIAGNOSIS: This species is recognized by the combination of the following characters: pronotum with median carina; apex of aedeagus rounded; and female sternum 8 with short arms.

DESCRIPTION: Holotype male. Body vestiture of setalike scales and setae. Frons with fovea. Eyes small (as long as half of rostrum height); supraocular sulcus absent. Rostrum with three slender, dorsal keels; lacking scales. Scrobes subtriangular; suprascrobal keel fine. Antenna with scape inflated; reaching hind margin of eye when resting in scrobe. *Pronotum* with apical impression poorly developed; median carina present; sulcus absent; not tuberculate; postocular lobes slightly developed. Metepisternal suture absent. Scu-

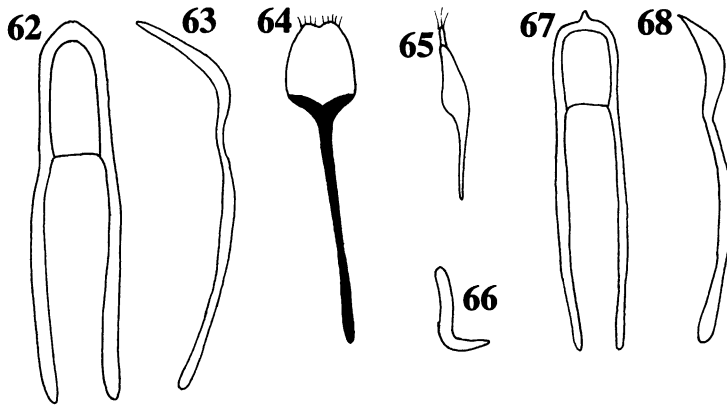

Figs. 62–68. Male and female genitalia. 62, 67, Aedeagus, dorsal view; 63, 68, aedeagus, lateral view; 64, female sternum 8; 65, hemisternites; 66, spermatheca; 62–66, *A. manu*; 67, 68, *A. morio*.

tellum prominent. *Elytra* with slightly convex intervals; with small tubercles; base of interval 3 flat; setae simple, slender, abundant. *Legs* with all tibiae mucronate; with one spur; lacking scales. *Body length* 2.4 mm.

Male Genitalia: Aedeagus (figs. 62, 63) with rounded apex; apodemes slightly longer than tube.

Female Genitalia: Sternum 8 (fig. 64) with very long apodeme (2.4× longer than plate); plate subelliptical, with sinuate apex and long setae; arms short. Hemisternites (fig. 65) 7.0× longer than wide. Spermatheca (fig. 66) lacking nodulus.

GEOGRAPHICAL DISTRIBUTION: Known only from the type locality in southern Peru (fig. 50), in the Punan biogeographic province of Cabrera and Willink (1973).

TYPE MATERIAL: Holotype male with the following labels: [PERU: Cuzco Dept./ Píllahuata, Manu Rd./ km. 128, 21.IX.1982/ L. Watrous & G. Mazurek/ leaf litt. after rain] [FIELD MUSEUM OF/ NATURAL HISTORY/ CHICAGO, IL, USA] [*Adioristidius/ manu* Morrone/ holotype male] (FMNH). One paratype with the same data (CMN).

ETYMOLOGY: I name this species after the Manu road, where its specimens were collected.

Adioristidius morio (Voss),
new combination
Figures 67, 68

Adioristus (Adioristidius) morio Voss, 1954: 252; Weidner, 1979: 402 (types).

Macrostyphlus morio; Kuschel, 1986: 117; Wibmer and O'Brien, 1986: 117 (checklist).

DIAGNOSIS: This species is recognized by the very small eyes (shorter than half of rostrum height). In addition, the following combination of characters is diagnostic: scape gradually widening toward apex; postocular lobes absent; all tibiae lacking mucro; and aedeagal apodemes more than twice length of tube.

REDESCRIPTION: Body vestiture lacking scales, only with setae. Frons with fovea. Eyes very small (shorter than half of rostrum height); supraocular sulcus absent. Rostrum with three slender, dorsal keels; lacking scales. Scrobes subtriangular; suprascrobal keel fine. Antenna with scape gradually widening toward apex; exceeding hind margin of eye when resting in scrobe. *Pronotum* lacking apical impression; median carina and sulcus absent; not tuberculate; postocular lobes absent. Metepisternal suture absent. Scutellum not prominent. *Elytra* with flat intervals; not tuberculate; base of interval 3 flat; setae simple, slender, abundant. *Legs* with all tibiae lacking mucro; with one spur; lacking scales. *Body length* 1.6–1.8 mm.

Male Genitalia: Aedeagus (figs. 67, 68) with produced apex; apodemes more than twice length of tube.

Female: Unknown.

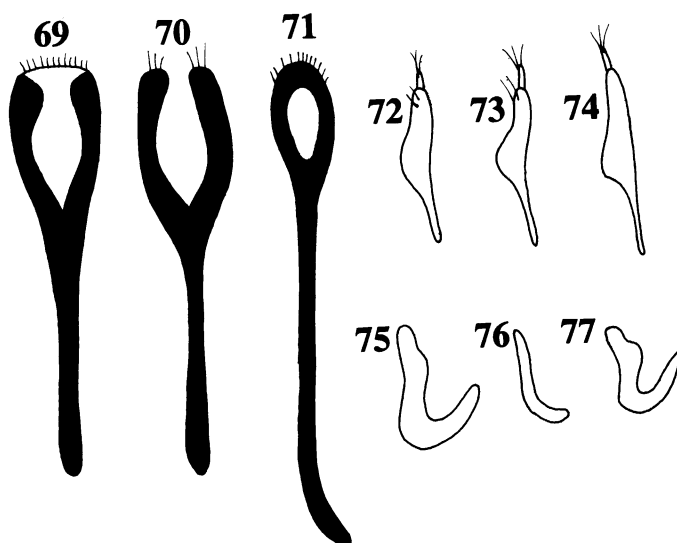

Figs. 69–77. Female genitalia. 69–71, Female sternum 8; 72–74, hemisternites; 75–77, spermatheca; 69, 72, 76, *A. nivalis*; 70, 73, 77, *A. puncticollis*; 71, 74, 77, *A. sulcicollis*.

GEOGRAPHICAL DISTRIBUTION: Known from Peru (fig. 50), in the Punan biogeographic province of Cabrera and Willink (1973).

MATERIAL EXAMINED: PERU. CUZCO: Andahuaylas-Ayacucho Rd., km 18, 4150 m, “puna,” 24-IV-1977, J. Mateu, 5 (4 CWOB, 1 MLP).

Adioristidius nivalis
(Kuschel), new combination
Figures 2, 69, 72, 76

Amathynetes nivalis Kuschel, 1949: 45.

Puranius nivalis; Kuschel, 1955: 289.

Macrostyphlus nivalis; Kuschel, 1986: 117; Wibmer and O’Brien, 1986: 117 (checklist).

DIAGNOSIS: This species is recognized by the combination of the following characters: body vestiture of subcircular scales; frons with fovea; and plate of female sternum 8 with entire apex.

REDESCRIPTION: Body vestiture of subcircular scales and setae. Frons with fovea. Eyes small (as long as half of rostrum height); supraocular sulcus absent. Rostrum lacking dorsal keels; lacking scales. Scrobes subtriangular; suprascrobal keel strongly developed. Antenna with scape inflated; reaching hind

margin of eye when resting in scrobe. *Pro-notum* (fig. 2) with apical impression poorly developed; median carina and sulcus absent; not tuberculate; postocular lobes slightly developed. Metepisternal suture absent. Scutellum prominent. *Elytra* (fig. 2) with flat intervals; not tuberculate; base of interval 3 flat; setae simple, slender, abundant. *Legs* with protibiae mucronate, meso- and metatibiae lacking mucro; pro- and mesotibiae lacking spurs, metatibiae with two spurs; lacking scales. *Body length* 2.4 mm.

Female Genitalia: Sternum 8 (fig. 69) with long apodeme (1.8 × longer than plate); plate subelliptical, with entire apex and short setae; arms long, reaching apex. Hemisternites (fig. 72) 5.0 × longer than wide. Spermatheca (fig. 76) with nodulus.

Male: Unknown.

GEOGRAPHICAL DISTRIBUTION: Known only from the type locality in northern Chile (fig. 83), in the Atacaman entomofaunal region of O’Brien (1971).

TYPE MATERIAL: Holotype female with the following labels: [CHILE. Tarapacá/ Tarapacá/ 4900 m/ 22.2.48] [Coll./ Kuschel] [HOLOTYPE FEMALE/ *Amathynetes/ nivalis/ Kuschel*] [*Macrostyphlus/ nivalis/ (Kuschel)* det. G. Kuschel/ 1981] (MHNS). One paratype with the same data (NZAC).

Adioristidius puncticollis
(Hustache), new combination
Figures 70, 73, 77

Adioristus puncticollis Hustache, 1938b: 286;
Blackwelder, 1947: 812 (checklist); Voss, 1954:
247 (subgenus *Adioristidius*).
Amathynetes puncticollis; Kuschel, 1949: 45.
Puranius puncticollis; Kuschel, 1955: 288.
Macrostyphlus puncticollis; Kuschel, 1986: 117;
Wibmer and O'Brien, 1986: 117 (checklist).

DIAGNOSIS: This species is recognized by the combination of the following characters: eyes medium-sized (as long as rostrum height); supraocular sulcus present; and abundant elytral setae.

REDESCRIPTION: Body vestiture lacking scales, only with setae. Frons with fovea. Eyes medium-sized (as long as rostrum height); supraocular sulcus present. Rostrum with three slender, dorsal keels; lacking scales. Scrobes subtriangular; suprascrobal keel fine. Antenna with scape inflated; reaching hind margin of eye when resting in scrobe. *Pronotum* lacking apical impression; median carina and sulcus absent; not tuberculate; postocular lobes slightly developed. Metepisternal suture absent. Scutellum not prominent. *Elytra* with flat intervals; not tuberculate; base of interval 3 flat; setae simple, slender, abundant. *Legs* with all tibiae mucronate; with one spur; lacking scales. *Body length* 3.0–3.8 mm.

Female Genitalia: Sternum 8 (fig. 70) with long apodeme (1.2 × longer than plate); plate subelliptical, with open apex and long setae; arms long, reaching apex. Hemisternites (fig. 73) 5.3 × longer than wide. Spermatheca (fig. 77) lacking nodulus.

Male: Unknown.

GEOGRAPHICAL DISTRIBUTION: Known from western Bolivia (fig. 83), in the Punan biogeographic province of Cabrera and Willink (1973).

TYPE MATERIAL: Lectotype female (here designated) with the following labels: [Boliv./4000 m.] [112.] [Coll. Pape] [Hustache/ det. 1938] [Syntypus] [Dtsch. Entomol./ Institut Berlin] [*Adioristus/ puncticollis/ m.*] [DEI/ Eberswalde] [*A. puncticollis/ Hust.*] [*Adioristus puncticollis* Hust./ lectotype female/ Morrone des.] (DEI). Three paralectotypes with the same data (DEI).

OTHER MATERIAL EXAMINED: BOLIVIA. LA PAZ: La Cumbre, 12 mi NE La Paz, 4600

m, 7-IV-1978, C. W. and L. O'Brien, 42 (38 CWOB, 4 MLP); 26 km S La Paz, 4030 m, "roadside ditch," 22-II-1978, P. J. Spangler, 5 (USNM).

Adioristidius similaris (Voss),
new combination

Adioristus (Adioristidius) similaris Voss, 1954: 250.
Macrostyphlus similaris; Kuschel, 1986: 117;
Wibmer and O'Brien, 1986: 117 (checklist).

DIAGNOSIS: This species is recognized by the combination of the following characters: suprascrobal keel absent; pronotal apical impression well developed; pro- and mesotibiae lacking mucro; and metatibiae lacking spurs.

REDESCRIPTION: Body vestiture of setalike scales and setae. Frons lacking fovea. Eyes small (as long as half of rostrum height); supraocular sulcus absent. Rostrum lacking dorsal keels; lacking scales. Scrobes subtriangular; suprascrobal keel absent. Antenna with scape inflated; exceeding hind margin of eye when resting in scrobe. *Pronotum* with apical impression well developed; median carina and sulcus absent; not tuberculate; postocular lobes well developed. Metepisternal suture absent. Scutellum prominent. *Elytra* with flat intervals; not tuberculate; base of interval 3 flat; setae simple, slender, abundant. *Legs* with pro- and mesotibiae lacking mucro, metatibiae mucronate; all tibiae lacking spurs; lacking scales. *Body length* 4.0 mm.

Male and Female Genitalia: Not dissected.

GEOGRAPHICAL DISTRIBUTION: Known only from the type locality, Peru.

TYPE MATERIAL: Lectotype male (here designated) with the following labels: [Pérou] [Coll. Kraatz] [Syntypus] [*Adioristus/ similaris/ n. sp./ det. E. Voss*] [Deutsch. Entomol./ Institut Berlin] [DEI/ Eberswalde] [*A. similaris/ Voss*] [*Adioristus similaris* Voss/ lectotype male/ Morrone des.] (DEI).

Adioristidius sulcicollis (Hustache),
new combination
Figures 71, 74, 77

Hyperodes sulcicollis Hustache, 1938a: 182;
Blackwelder, 1947: 814 (checklist).
Amathynetes sulcicollis; Kuschel, 1949: 45.
Puranius sulcicollis; Kuschel, 1955: 288.
Listronotus sulcicollis; O'Brien, 1979: 268.
Macrostyphlus sulcicollis; Kuschel, 1986: 117;
Wibmer and O'Brien, 1986: 117 (checklist).

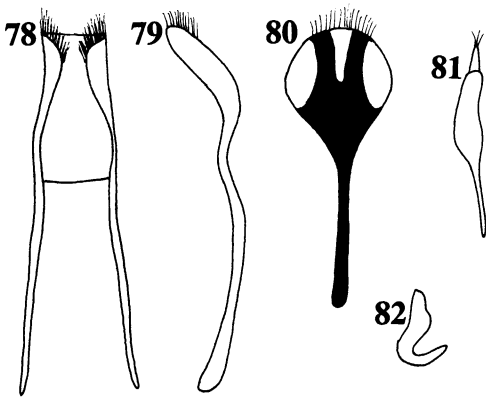

Figs. 78–82. *Adioristidius tuberculatus*, male and female genitalia. 78, aedeagus, dorsal view; 79, aedeagus, lateral view; 80, female sternum 8; 81, hemisternites; 82, spermatheca.

DIAGNOSIS: This species is recognized by the combination of the following characters: eyes medium-sized (as long as rostrum height); suprascrobal keel absent; antennal scape exceeding hind margin of eye when resting in scrobe; pronotum with median sulcus; elytral setae multifid; and spermatheca with nodulus.

REDESCRIPTION: Body vestiture of subcircular scales and setae. Frons with fovea. Eyes medium-sized (as long as rostrum height); supraocular sulcus absent. Rostrum with three slender, dorsal keels; squamose. Scrobes linear; suprascrobal keel absent. Antenna with scape inflated; exceeding hind margin of eye when resting in scrobe. *Pronotum* with apical impression poorly developed; median carina absent; median sulcus present; with small tubercles; postocular lobes well developed. Metepisternal suture absent. Scutellum not prominent. *Elytra* with slightly convex intervals; with small tubercles; base of interval 3 slightly prominent; setae multifid, strong, abundant. *Legs* with all tibiae mucronate; with one spur; squamose. *Body length* 2.4 mm.

Female Genitalia: Sternum 8 (fig. 71) with very long apodeme ($3.2\times$ longer than plate); plate subelliptical, with entire apex and short setae; arms long, reaching apex. Hemisternites (fig. 74) $6.2\times$ longer than wide. Spermatheca (fig. 77) with nodulus.

Male: Unknown.

GEOGRAPHICAL DISTRIBUTION: Known only from the type locality, Bolivia.

TYPE MATERIAL: Lectotype female (here designated) with the following labels: [Bolivia/ Germain] [Coll. Kraatz] [TYPE] [Hustache/ det. 1938] [syntypus] [*Hyperodes/ sulcicollis/ m./ Hustache det.*] [DEI/ Eberswalde] [*Hyperodes/ sulcicollis* Hust.] [*Hyperodes sulcicollis* Hust./ Lectotype female/ Morrone des.] (DEI). One paralectotype with the same data (DEI).

Adioristidius tuberculatus
(Voss), new combination

Figures 78–82

Adioristus (Anchadioristus) tuberculatus Voss, 1954: 258; Weidner, 1979: 402 (types).

Macrostyphlus tuberculatus; Kuschel, 1986: 118; Wibmer and O'Brien, 1986: 118 (checklist).

DIAGNOSIS: This species is recognized by the apex of the aedeagus with hairs (character unique in the Rhytirrhini). In addition, the following combination of characters is diagnostic: frons lacking fovea; supraocular sulcus present; rostrum with three dorsal keels; pronotum with median carina and well developed, apical impression; metepisternal suture present; elytral setae bifid; and meso- and metatibiae lacking spurs.

REDESCRIPTION: Body vestiture of setalike scales and setae. Frons lacking fovea. Eyes small (as long as half of rostrum height); supraocular sulcus present. Rostrum with three strong, dorsal keels; lacking scales. Scrobes subtriangular; suprascrobal keel strongly developed. Antenna with scape inflated; reaching hind margin of eye when resting in scrobe. *Pronotum* with apical impression well developed; median carina present; median sulcus absent; with small tubercles; postocular lobes well developed. Metepisternal suture present. Scutellum not prominent. *Elytra* with slightly convex intervals; with small tubercles; base of interval 3 flat; setae bifid, strong, abundant. *Legs* with all tibiae mucronate; protibiae with one spur, meso- and metatibiae lacking spurs; lacking scales. *Body length* 3.3–4.1 mm.

Male Genitalia: Aedeagus (figs. 78, 79) with apex straight, with hairs; apodemes slightly longer than tube.

Female Genitalia: Sternum 8 (fig. 80) with

long apodeme ($1.4 \times$ longer than plate); plate subcircular, with entire apex and long setae; arms long, reaching apex. Hemisternites (fig. 81) $6.0 \times$ longer than wide. Spermatheca (fig. 82) lacking nodulus.

GEOGRAPHICAL DISTRIBUTION: Known from southwestern Bolivia and southern Peru (fig. 83), in the Punan biogeographic province of Cabrera and Willink (1973).

MATERIAL EXAMINED: BOLIVIA. LA PAZ: La Paz, 2-XII-1952, "root borers," 6 (USNM). PERU. CUZCO: Sicuaní, 17-IX-1915, 6 (USNM). HUANCVELICA: Huancavelica, EEASC # 41, "in potato field under clods," 1973, Alcalá, 18 (CWOB), EEASC # 52, "in soil, potato," 1974, J. Alata, 9 (CWOB).

Adioristidius variegatus (Voss),
new combination

Adioristus (*Adioristidius*) *variegatus* Voss, 1954: 244.

Macrostyphlus variegatus; Kuschel, 1986: 118; Wibmer and O'Brien, 1986: 118 (checklist).

DIAGNOSIS: This species is recognized by the combination of suprascrobal keel absent and scape exceeding hind margin of eye when resting in scrobe.

REDESCRIPTION: Body vestiture of setalike scales and setae. Frons lacking fovea. Eyes small (as long as half of rostrum height); supraocular sulcus absent. Rostrum lacking dorsal keels; lacking scales. Scrobes subtriangular; suprascrobal keel absent. Antenna with scape inflated; exceeding hind margin of eye when resting in scrobe. *Pronotum* lacking apical impression; median carina and sulcus absent; not tuberculate; postocular lobes absent. Metepisternal suture absent. Scutellum not prominent. *Elytra* with flat intervals; not tuberculate; base of interval 3 flat; setae simple, slender, abundant. *Legs* with all tibiae mucronate; lacking spurs; lacking scales. *Body length* 3.5 mm.

Male and Female Genitalia: Not dissected.

GEOGRAPHICAL DISTRIBUTION: Known only from the type locality, Bolivia.

TYPE MATERIAL: Lectotype male (here designated) with the following labels: [Bolivien/German] [Coll. Kraatz] [Syntypus] [*Adioristus*/*variegatus*/ n. sp./ det. E. Voss] [DEI/ Eberswalde] [*A. variegatus*/ Voss] [*Adioristus*

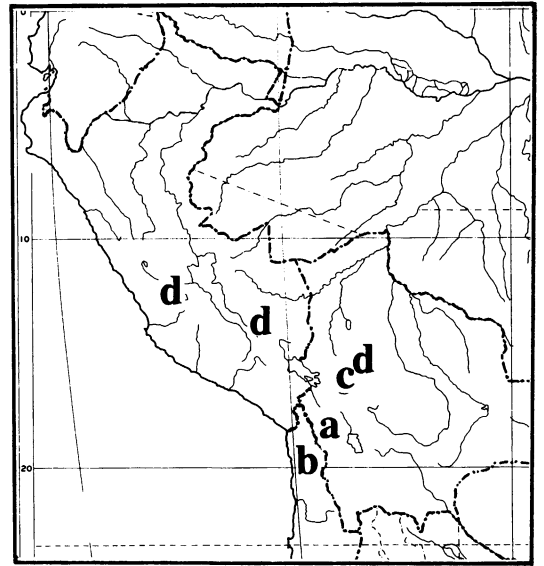

Fig. 83. Geographical distribution of the genus *Adioristidius*. a, *A. lidiae*; b, *A. nivalis*; c, *A. puncticollis*; d, *A. tuberculatus*.

variegatus Voss/ lectotype male/ Morrone des.] (DEI).

Other Species in *Adioristidius*

Type specimens of nine species described by Voss (1954) were destroyed during World War II (Weidner, 1979). Among the specimens examined, I was able to identify *A. morio* and *A. tuberculatus*; the remaining species are here provisionally assigned to *Adioristidius*.

Adioristidius carinicollis
(Voss), new combination

Adioristus (*Adioristidius*) *carinicollis* Voss, 1954: 255; Weidner, 1979: 402 (types).

Macrostyphlus carinicollis; Kuschel, 1986: 116; Wibmer and O'Brien, 1986: 116 (checklist).

Adioristidius cuprisquameus
(Voss), new combination

Adioristus (*Adioristidius*) *cuprisquameus* Voss, 1954: 254; Weidner, 1979: 402 (types).

Macrostyphlus cuprisquameus; Kuschel, 1986: 116; Wibmer and O'Brien, 1986: 116 (checklist).

Adioristidius pampaensis

(Voss), new combination

Adioristus (Adioristidius) pampaensis Voss, 1954: 256; Weidner, 1979: 402 (types).*Macrostyphlus pampaensis*; Kuschel, 1986: 117; Wibmer and O'Brien, 1986: 117 (checklist).*Adioristidius peruvianus*

(Voss), new combination

Adioristus (Adioristidius) peruvianus Voss, 1954: 253; Weidner, 1979: 402 (types).*Macrostyphlus peruvianus*; Kuschel, 1986: 117; Wibmer and O'Brien, 1986: 117 (checklist).*Adioristidius scrobicollis*

(Voss), new combination

Adioristus (Adioristidius) scrobicollis Voss, 1954: 256; Weidner, 1979: 402 (types).*Macrostyphlus scrobicollis*; Kuschel, 1986: 117; Wibmer and O'Brien, 1986: 117 (checklist).*Adioristidius subimpressus*

(Voss), new combination

Adioristus (Adioristidius) subimpressus Voss, 1954: 250; Weidner, 1979: 402 (types).*Macrostyphlus subimpressus*; Kuschel, 1986: 117; Wibmer and O'Brien, 1986: 117 (checklist).*Adioristidius subtuberculatus*

(Voss), new combination

Adioristus (Anchadoristus) subtuberculatus Voss, 1954: 257; Weidner, 1979: 402 (types).*Macrostyphlus subtuberculatus*; Kuschel, 1986: 117; Wibmer and O'Brien, 1986: 117 (checklist).**AMATHYNETOIDES, NEW GENUS**Type species: *Amathynetes appendiculatus* Kuschel, 1949.*Amathynetes* Kuschel, 1949: 43 (misidentification, in part, not Olliff, 1891), 1955: 288 (= *Puranius*).**DIAGNOSIS:** The species of this genus are recognized by the smooth integument, the pronotum with subparallel flanks, and the elytra with sparse setae.**REDESCRIPTION:** Very small to medium-sized (body length 3.0–6.6 mm). Integument smooth, dark brown to black. Body vestiture of setalike scales and setae, or only setae. Frons with fovea or lacking it. Eyes small(as long as half of rostrum height), flat (convex only in *A. ebeninus*); supraocular sulcus absent. Rostrum with three dorsal keels, or lacking them; lacking scales. Antenna with funicular articles 3–6 monilliform; club ovate. *Pronotum* (fig. 3) with subparallel flanks; lacking apical impression, sulcus, and median carina; not tuberculate; postocular lobes usually poorly developed. Metepisternal suture present or absent. Scutellum prominent or not. *Elytra* (fig. 3) usually ovate (elongate-ovate only in *A. longulus*), with rounded humeri; base of interval 3 flat; intervals flat; not tuberculate; setae simple, curved, tapered, sparse. *Legs* with pro- and mesotibiae mucronate; with 1–2 spurs or lacking them; lacking scales.**Male Genitalia:** Aedeagus with apex variable in shape; usually apodemes slightly longer than tube.**Female Genitalia:** Sternum 8 with apodeme usually long (fig. 87); plate subelliptical (fig. 92) or subrectangular (fig. 87); sclerotized arms usually long, reaching apex. Hemisternites elongate (fig. 93) or subtriangular (fig. 108); usually with baculi (absent in *A. ebeninus*); styli present. Spermatheca with enlarged ramus (fig. 89); nodulus present (fig. 103) or absent (fig. 101).**BIOLOGY:** Unknown.**CLADISTICS:** The following characters were analyzed:

1. **ROSTRAL DORSAL KEELS.** [0] present; [1] absent.
2. **SCROBES.** [0] linear; [1] subtriangular.
3. **SUPRASCROBAL KEEL.** [0] absent; [1] present, fine; [2] present, strong.
4. **SCAPE.** [0] exceeding hind margin of eye when resting in scrobe; [1] reaching hind margin of eye when resting in scrobe; [2] not reaching eye when resting in scrobe.
5. **SCAPE.** [0] gradually widening toward apex; [1] inflated.
6. **POSTOCULAR LOBES.** [0] present; [1] absent.
7. **METEPISTERNAL SUTURE.** [0] present; [1] absent.
8. **SCALES.** [0] present; [1] absent.
9. **METATIBIAL MUCRO.** [0] present; [1] absent.
10. **PROTIBIAL SPURS.** [0] two; [1] one; [2] absent.

TABLE 5
Data Matrix for *Amathynetoides*, new genus

	1												
	1	2	3	4	5	6	7	8	9	0	1	2	3
<i>Listroderes</i>	0	0	0	0	0	0	0	0	0	0	0	0	0
<i>A. appendiculatus</i>	1	1	1	1	1	1	1	1	0	2	2	2	1
<i>A. ebeninus</i>	1	1	0	0	1	0	0	0	0	0	0	1	0
<i>A. intemperatus</i>	1	1	1	1	1	0	1	1	0	0	0	0	1
<i>A. longulus</i>	1	0	1	1	1	0	1	1	1	0	0	1	0
<i>A. morbeamus</i>	0	1	2	2	1	0	1	0	1	0	0	0	0
<i>A. nitidiventris</i>	0	1	1	0	1	0	0	0	0	0	1	1	1
<i>A. normae</i>	0	1	1	0	0	0	0	0	0	0	0	0	0
<i>A. palustris</i>	1	1	1	1	1	1	1	1	1	0	0	1	0
<i>A. sparsesetosus</i>	1	0	1	1	1	0	0	1	0	0	0	0	?
<i>A. sundrianus</i>	0	1	1	1	1	0	0	1	0	0	2	2	0

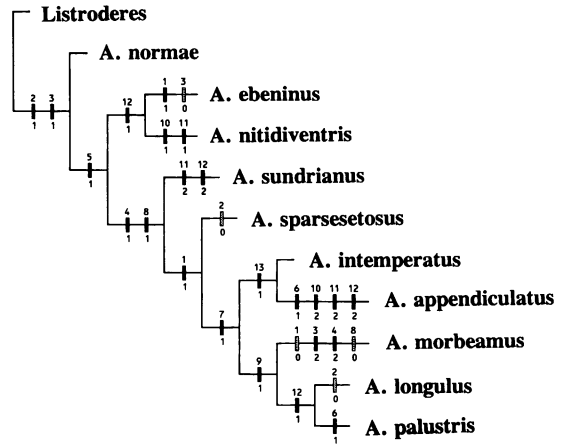

Fig. 84. Cladogram of species of the genus *Amathynetoides*.

- 11. MESOTIBIAL SPURS. [0] two; [1] one; [2] absent.
- 12. METATIBIAL SPURS. [0] two; [1] one; [2] absent.
- 13. SPERMATHECAL NODULUS. [0] present (fig. 103); [1] absent (fig. 101).

The analysis of the data matrix (table 5) led to three cladograms with 28 steps, a consistency index of 0.64, and a retention index of 0.64. Successive weighting led to one cladogram (fig. 84), with 97 steps, a consistency index improved to 0.90, and a retention index improved to 0.93. In the cladogram, the species follow the following sequence: *A. normae*, *A. ebeninus* plus *A. nitidiventris*, *A. sundrianus*, *A. sparsesetosus*, *A. intemperatus* plus *A. appendiculatus*, *A. morbeamus*, *A. longulus*, and *A. palustris*.

GEOGRAPHICAL DISTRIBUTION: Species of *Amathynetoides* are found in northern Chile, Bolivia, and southern Peru (figs. 104, 113, 119), in the Puna biogeographic province of the Andeanpatagonian dominion of Cabrera and Willink (1973). Three species (*A. appendiculatus*, *A. longulus*, and *A. palustris*) are distributed in the Desert province of the same dominion. Biogeographical patterns of this genus are analyzed under "Geographical distribution" of *Puranius*.

ETYMOLOGY: The name *Amathynetoides* refers to the superficial similarity of this genus to *Amathynetes*, currently a synonym of *Cylydrorhinus* (Entimini).

KEY TO SPECIES OF *AMATHYNETOIDES*

- 1. Body vestiture of scales and setae 2
 - 1a. Body vestiture lacking scales, only with setae 5
 - 2. Suprascrobal keel present; scape not reaching hind margin of eye when resting in scrobe; metepisternal suture absent; metatibiae lacking mucro; Peru *A. morbeamus*, n. sp.
 - 2a. Suprascrobal keel absent; scape exceeding hind margin of eye when resting in scrobe; metepisternal suture present; metatibiae mucronate 3
 - 3. Eyes convex; rostrum lacking dorsal keels; Peru *A. ebeninus* (Hustache)
 - 3a. Eyes flat; rostrum with dorsal keels 4
 - 4. Scape inflated; tibiae lacking spurs; Bolivia *A. nitidiventris* (Hustache)
 - 4a. Scape gradually widening toward apex; tibiae with one spur; Bolivia *A. normae*, n. sp.
 - 5. Metepisternal suture present 6
 - 5a. Metepisternal suture absent 7
 - 6. Integument dark brown; rostrum lacking dorsal keels; scrobes linear; meso- and metatibiae with one spur; < 4.0 mm body length; Bolivia and Peru *A. sparsesetosus* (Hustache)
 - 6a. Integument black; rostrum with three dorsal keels; scrobes subtriangular; meso- and metatibiae with two spurs; > 4.1 mm body length; Peru *A. sundrianus*, n. sp.
 - 7. Metatibiae lacking mucro; spermatheca with nodulus 8
 - 7a. Metatibiae mucronate; spermatheca lacking nodulus 9
 - 8. Scrobes linear; pronotum with slightly devel-

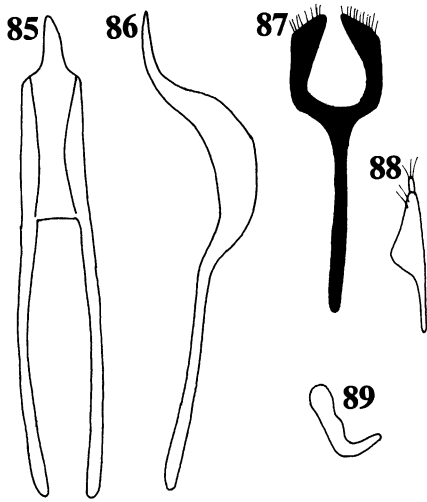

Figs. 85–89. *Amathynetoides appendiculatus*, male and female genitalia. **85**, Aedeagus, dorsal view; **86**, aedeagus, lateral view; **87**, female sternum 8; **88**, hemisternites; **89**, spermatheca.

- oped postocular lobes; elytra elongate-ovate; northern Chile and Peru *A. longulus* (Kuschel)
- 8a. Scrobes subtriangular; pronotum lacking postocular lobes; elytra ovate; northern Chile, Bolivia, and Peru *A. palustris* (Kuschel)
- 9. Integument dark brown; pronotum lacking postocular lobes; all tibiae lacking spurs; < 5.0 mm body length; northern Chile, Bolivia, and Peru *A. appendiculatus* (Kuschel)
- 9a. Integument black; pronotum with postocular lobes; all tibiae with one spur; > 5.1 mm body length; Peru *A. intemperatus*, n. sp.

Amathynetoides appendiculatus
(Kuschel), new combination
Figures 85–89

Amathynetes appendiculatus Kuschel, 1949: 47.
Puranius appendiculatus; Kuschel, 1955: 288.
Macrostyphlus appendiculatus; Kuschel, 1986: 116;
Wibmer and O'Brien, 1986: 116 (checklist).

DIAGNOSIS: This species is recognized by the combination of body vestiture of setae and spermatheca lacking nodulus.

REDESCRIPTION: Integument black. Body vestiture lacking scales, only with setae. Frons lacking fovea. Eyes flat. Rostrum lacking dor-

sal keels. Scrobes subtriangular; suprascrobal keel fine. Antenna with scape inflated, reaching hind margin of eye when resting in scrobe. *Pronotum* lacking postocular lobes. Metepisternal suture absent. Scutellum not prominent. *Elytra* ovate. *Legs* with all tibiae mucronate; lacking spurs. *Body length* 3.0–4.5 mm.

Male Genitalia: Aedeagus (figs. 85, 86) with pointed apex, not incised; apodemes slightly longer than tube.

Female Genitalia: Sternum 8 (fig. 87) with long apodeme (2.0 × longer than plate); plate subrectangular, with open apex and long setae; arms long, reaching apex. Hemisternites (fig. 88) subtriangular, 4.0 × longer than wide; with baculi. Spermatheca (fig. 89) lacking nodulus.

GEOGRAPHICAL DISTRIBUTION: Known from northern Chile, southwestern Bolivia, and southern Peru (fig. 104). Distribution in Chile lies in the Atacaman entomofaunal region of O'Brien (1971).

TYPE MATERIAL: Holotype male with the following labels: [CHILE. Tarapacá/ Parinacota/ 4400 m/ 27.2.48] [Coll. Kuschel] [HOLOTYPE MALE/ *Amathynetes/ appendiculatus/* Kuschel] [*Macrostyphlus/ appendiculatus/* (Kuschel)/ det. G. Kuschel/ 1981] (MHNS). Allotype and five paratypes with the same data (1 MHNS, 3 NZAC, 2 USNM). Two paratypes with the following labels: [male] [Parinacota/ 4.500 m/ 1.3.48] [Arica/ Kuschel] [PARATIPO] [*Amathynetes/ appendicula-/ tus* Kuschel/ Kuschel det. 1949] (USNM).

OTHER MATERIAL EXAMINED: BOLIVIA. COCHABAMBA: 7 mi SE Challa, 5-IV-1978, C. W. and L. O'Brien, 1 (CWOB); 18 mi W Challa, 5-IV-1978, C. W. and L. O'Brien and B. Marshall, 58 (CWOB); 19 mi E Cochabamba, 2-IV-1978, L. and C. W. O'Brien, 3 (CWOB); 24 mi NE Cochabamba, 2-IV-1978, C. W. and L. O'Brien and G. B. Marshall, 2 (CWOB); 55 mi SW Cochabamba, 5-IV-1978, C. W. and L. O'Brien, 47 (CWOB); 62 mi SW Cochabamba, 5-IV-1978, G. B. Marshall, 10 (CWOB), 5-IV-1978, C. W. and L. O'Brien, 15 (CWOB); Toralapa, 75 km SE Cochabamba, 3800 m, 3-IV-1978, C. W. and L. O'Brien, 50 (CWOB), 3-IV-1978, G. B. Marshall, 5 (CWOB). LA PAZ: 7 mi NW Alta La Paz, "under stones," 9-IV-1978, G. B.

Marshall, 1 (CWOB); N Calamarca, 24-I-1976, L. E. Peña, 1 (HAHC); La Cumbre, 12 mi NE La Paz, 4600 m, 7-IV-1978, C. W. and L. O'Brien, 121 (CWOB); 18 mi NE La Paz, 4000 m, 7-IV-1978, C. W. and L. O'Brien and Marshall, 14 (CWOB). ORURO: Laquepalga/ Challa, 4200–4300 m, 25-I-1976, L. E. Peña, 1 (HAHC); Pongo, 4200 m, 25-I-1976, L. E. Peña, 1 (HAHC). POTOSI: W Las Leñas, 4000 m, 26-II-1976, L. E. Peña, 26-II-1976, 1 (HAHC); E Macha, 4000 m, 29-II-1976, L. E. Peña, 5 (HAHC), 4100 m, 29-II-1976, L. E. Peña, 1 (HAHC); E Ocuri, 4000 m, 1-III-1976, L. E. Peña, 2 (HAHC). CHILE. ARICA: Caquena, 4300 m, 25-I-1970, 1 (MHNS). PERU. CASTROVIRREINA: Apacheta, Cuyo-Cuyo, 5100 m, E Tiawanacu, 29-XII-1975, L. E. Peña, 1 (HAHC).

Amathynetoides ebeninus
(Hustache), new combination

Figures 3, 90–94

Adioristus ebeninus Hustache, 1938b: 287; Blackwelder, 1947: 812 (checklist); Voss, 1954: 245 (subgenus *Adioristidius*).

Amathynetes ebeninus; Kuschel, 1949: 45.

Puranius ebeninus; Kuschel, 1955: 288.

Macrostyphlus ebeninus; Kuschel, 1986: 116; Wibmer and O'Brien, 1986: 116 (checklist).

DIAGNOSIS: This species is recognized by the convex eyes and female hemisternites lacking baculi. In addition, the combination of the following characters is diagnostic: rostrum lacking dorsal keels; suprascrobal keel absent; and scutellum prominent.

REDESCRIPTION: Integument dark brown. Body vestiture of setalike scales and setae. Frons with fovea. Eyes convex. Rostrum lacking dorsal keels. Scrobes subtriangular; suprascrobal keel absent. Antenna with scape inflated, exceeding hind margin of eye when resting in scrobe. *Pronotum* (fig. 3) with slightly developed postocular lobes. Metepisternal suture present. Scutellum prominent. *Elytra* (fig. 3) ovate. *Legs* with all tibiae mucronate; pro- and mesotibiae with one spur; metatibiae with two spurs. *Body length* 3.9–4.9 mm.

Male Genitalia: Aedeagus (figs. 90, 91) with rounded apex, not incised; apodemes slightly longer than tube.

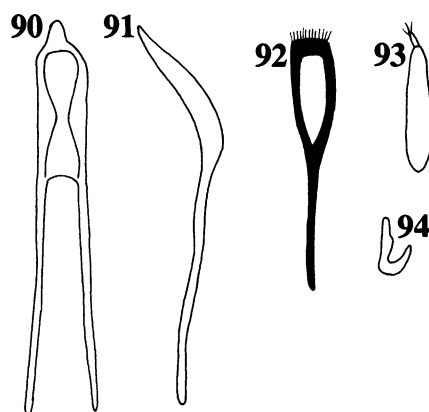

Figs. 90–94. *Amathynetoides ebeninus*, male and female genitalia. 90, Aedeagus, dorsal view; 91, aedeagus, lateral view; 92, female sternum 8; 93, hemisternites; 94, spermatheca.

Female Genitalia: Sternum 8 (fig. 92) with long apodeme (as long as plate); plate subelliptical, with straight apex and short setae; arms long, reaching apex. Hemisternites (fig. 93) elongate, 4.5× longer than wide; lacking baculi. Spermatheca (fig. 94) lacking nodulus.

GEOGRAPHICAL DISTRIBUTION: Known from southern Peru (fig. 104), in the Punan biogeographic province of Cabrera and Willink (1973).

TYPE MATERIAL: Lectotype male (here designated) with the following labels: [Peru] [Coll. Kraatz] [Hustache/ det. 1938] [Syntypus] [*Adioristus/ ebeninus/ m.*] [DEI/ Eberswalde] [*Adioristus ebeninus/ Hust.*] [lectotype male/ Morrone des.] (DEI).

OTHER MATERIAL EXAMINED: PERU. AYACUCHO: Andahuaylas-Ayacucho Road, km 18, 4150 m, “puna,” 24-IV-1977, J. Mateu, 2 (CWOB); Castrovirreina Road, km 99, 4730 m, 25-IV-1977, J. Mateu, 4 (CWOB). PUNO: Puno, 24-X-1970, J. and M. Sedlacek, 3 (BPBM). Junín: Tarma-Jauja Road, 21-III-1977, J. Mateu, 3 (CWOB); km 39 on Tarma-Jauja Road, 4200 m, 21-III-1977, J. Mateu, 1 (CWOB).

Amathynetoides intemperatus,
new species

Figures 95, 98, 101

DIAGNOSIS: This species is recognized by the combination of frons lacking fovea and rostrum lacking dorsal keels.

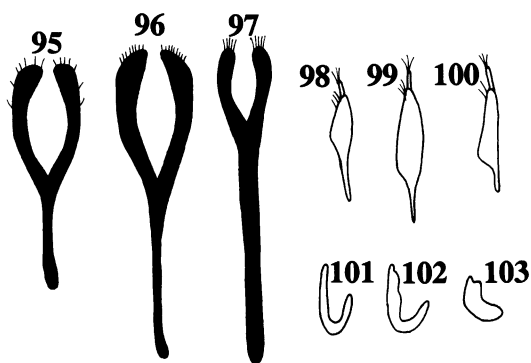

Figs. 95–103. Female genitalia. 95–97, female sternum 8; 98–100, hemisternites; 101–103, spermatheca; 95, 98, 101, *Amathynetoides intemperatus*; 96, 99, 102, *A. longulus*; 97, 100, 103, *A. morbeamus*.

DESCRIPTION: Holotype female. Integument black. Body vestiture lacking scales, only with setae. Frons lacking fovea. Eyes flat. Rostrum lacking dorsal keels. Scrobes subtriangular; suprascrobal keel fine. Antenna with scape inflated, reaching hind margin of eye when resting in scrobe. *Pronotum* with slightly developed postocular lobes. Metepisternal suture absent. Scutellum not prominent. *Elytra* ovate. *Legs* with all tibiae mucronate; with one spur. *Body length* 6.6 mm.

Female Genitalia: Sternum 8 (fig. 95) with short apodeme ($0.7 \times$ longer than plate); plate subelliptical, with open apex and short setae; arms long, reaching apex. Hemisternites (fig. 98) elongate, $5.3 \times$ longer than wide; with baculi. Spermatheca (fig. 101) lacking nodulus.

Male: Unknown.

GEOGRAPHICAL DISTRIBUTION: Known from southern Peru (fig. 104), in the Punan biogeographic province of Cabrera and Wilink (1973).

TYPE MATERIAL: Holotype female with the following labels: [PERU, Border D./ Lima & E. Junín, / Abra de Anticona] [Ticlio, 4850 m./ April 3, 1977/ J. Mateu] [*Amathynetoides/ intemperatus* Morrone/ holotype female] (CWOB). Fifteen paratypes with the same data (3 AMNH, 9 CWOB, 3 MLP). Four paratypes with the following labels: [PERU, Lima/ El Ticho/ Mar. 19, 1977/ J. Mateu] [*Amathynetoides/ intemperatus* Morrone/ paratype] (2 BMNH, 2 CWOB). Three paratypes with the following labels: [PERU,

Ica/ 5-IV-1977/ J. Mateu] [*Amathynetoides/ intemperatus* Morrone/ paratype] (CWOB).

ETYMOLOGY: From the Latin *intemperatus* for excessive, referring to the body length of the species.

Amathynetoides longulus
(Kuschel), new combination
Figures 96, 99, 102

Amathynetes longulus Kuschel, 1949: 49.

Puranius longulus; Kuschel, 1955: 288.

Macrostyphlus longulus; Kuschel, 1986: 117; Wibmer and O'Brien, 1986: 117 (checklist).

DIAGNOSIS: This species is recognized by the elongate-ovate elytra. In addition, the combination of the following characters is diagnostic: rostrum lacking dorsal keels; scrobes linear; postocular lobes slightly developed; and metatibiae with two spurs.

REDESCRIPTION: Integument dark brown. Body vestiture lacking scales, only with setae. Frons with fovea. Eyes flat. Rostrum lacking dorsal keels. Scrobes linear; suprascrobal keel fine. Antenna with scape inflated, reaching hind margin of eye when resting in scrobe. *Pronotum* with slightly developed postocular lobes. Metepisternal suture absent. Scutellum not prominent. *Elytra* elongate-ovate. *Legs* with pro- and mesotibiae mucronate, metatibiae lacking mucro; pro- and mesotibiae with ones spur, metatibiae with two spurs. *Body length* 3.8–5.9 mm.

Female Genitalia: Sternum 8 (fig. 96) with long apodeme (as long as plate); plate subelliptical, with open apex and short setae; arms long, reaching apex. Hemisternites (fig. 99) elongate, $5.7 \times$ longer than wide; with baculi. Spermatheca (fig. 102) with nodulus.

Male: Unknown.

GEOGRAPHICAL DISTRIBUTION: Known from northern Chile and Peru (fig. 113). Distribution in Chile lies in the Atacaman entomofaunal region of O'Brien (1971)

TYPE MATERIAL: Holotype female with the following labels: [CHILE. Tarapacá/ Parinacota/ 4400 m/ 7.12.46] [Coll. Kuschel] [HOLOTYPE FEMALE/ *Amathynetes/ longulus/ Kuschel*] [*Macrostyphlus/ longulus/ Kuschel*] / det. G. Kuschel/ 1981] (MHNS). Two paratypes with the same data (NZAC). One paratype with the same data except 27.2.48 (MHNS). One paratype with the same data except 29.2.48 (NZAC). One paratype

with the following labels: [female] [Parinacota/ 4.500 m/ 1.3.48] [Arica/ Kuschel] [PARATIPO] [*Amathynetes/ longulus/ Kuschel/ Kuschel det. 1949*] (USNM).

OTHER MATERIAL EXAMINED: CHILE. ARICA: Tarapacá, 10-VIII-1927, J. Solervicens, 1 (MHNS), Villa Industrial, 4200 m, Soza, 3 (2 CWOB, 1 MHNS). IQUIQUE: Chapiquilla, 10-VII-1967, J. Solervicens, 1 (CWOB). PERU. AYACUCHO: Andahuaylas-Ayacucho Road, km 18, 4150 m, "puna," J. Mateu, 7 (CWOB); Castrovirreina Road, km 99, 4730 m, 25-IV-1977, J. Mateu, 11 (CWOB).

Amathynetoides morbeamus,

new species

Figures 97, 100, 103

DIAGNOSIS: This species is recognized by the combination of the following characters: body vestiture of setalike scales; scape not reaching hind margin of eye when resting in scrobe; scutellum prominent; and apodeme of female sternum 8 very long.

DESCRIPTION: Holotype female. Integument black. Body vestiture of setalike scales and setae. Frons with fovea. Eyes flat. Rostrum with three slender, dorsal keels. Scrobes subtriangular; suprascrobal keel strongly developed. Antenna with scape inflated, not reaching hind margin of eye when resting in scrobe. *Pronotum* with slightly developed postocular lobes. Metepisternal suture absent. Scutellum prominent. *Elytra* ovate. *Legs* with pro- and mesotibiae mucronate, metatibiae lacking mucro; all tibiae with one spur. *Body length* 3.9 mm.

Female Genitalia: Sternum 8 (fig. 97) with very long apodeme (2.2× longer than plate); plate subelliptical, with open apex and long setae; arms long, reaching apex. Hemisternites (fig. 100) elongate, 5.1× longer than wide; with baculi. Spermatheca (fig. 103) with nodulus.

Male: Unknown.

GEOGRAPHICAL DISTRIBUTION: Known only from the type locality in Peru, which could not be located on the map.

TYPE MATERIAL: Holotype female with the following labels: [C-PERU/ laguna Conococha,/ 4150 m, 8.III.1956/ leg. W. Weyrauch] [WKW/ 6500] [ex-col. Weyrauch] [COLECCION/ Fundación M. Lillo/ 4000 S. M. Tu-

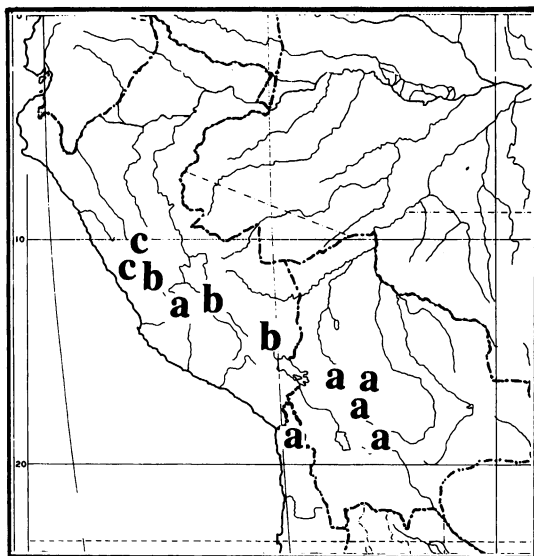

Fig. 104. Geographical distribution of the genus *Amathynetoides*. a, *A. appendiculatus*; b, *A. ebeninus*; c, *A. intemperatus*.

cumán/ TUCUMAN-ARGENTINA] [*Amathynetoides/ morbeamus* Morrone/ holotype female] (FIML).

ETYMOLOGY: From the Anglo-Saxon *morbeam* for mulberry, referring to the black color of the integument of this species.

Amathynetoides nitidiventris
(Hustache), new combination

Adioristus nitidiventris Hustache, 1938b: 285; Blackwelder, 1947: 812 (checklist); Voss, 1954: 245 (subgenus *Adioristidius*).

Amathynetes nitidiventris; Kuschel, 1949: 45.

Puranius nitidiventris; Kuschel, 1955: 288.

Macrostyphlus nitidiventris; Kuschel, 1986: 117; Wibmer and O'Brien, 1986: 117 (checklist).

DIAGNOSIS: This species is recognized by the combination of pro- and mesotibiae with two spurs, and metatibiae with one spur.

REDESCRIPTION: Integument dark brown. Body vestiture of setalike scales and setae. Frons with fovea. Eyes flat. Rostrum with three slender, dorsal keels. Scrobes subtriangular; suprascrobal keel fine. Antenna with scape inflated, exceeding hind margin of eye when resting in scrobe. *Pronotum* with slightly developed postocular lobes. Metepisternal suture present. Scutellum not prominent. *El-*

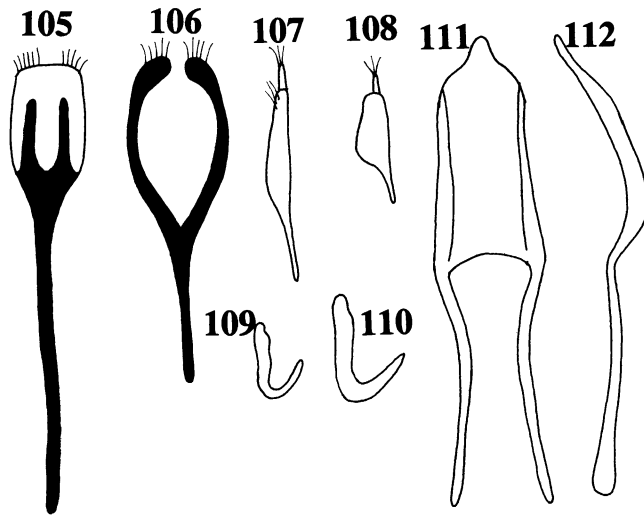

Figs. 105–112. Male and female genitalia. **105, 106**, female sternum 8; **107, 108**, hemisternites; **109, 110**, spermatheca; **111**, aedeagus, dorsal view; **112**, aedeagus, alteral view; **105, 107, 109**, *Amathynetoides normae*; **106, 108, 110**, *A. palustris*; **111, 112**, *A. sparsesetosus*.

ytra ovate. *Legs* with all tibiae mucronate; pro- and mesotibiae with two spurs, metatibiae with one spur. *Body length* 3.5–3.8 mm.

Male and Female Genitalia: Not dissected.

GEOGRAPHICAL DISTRIBUTION: Known only from the type locality, Bolivia.

TYPE MATERIAL: Lectotype male (here designated) with the following labels: [Bolivien/ Germain] [Coll. Kraatz] [Hustache/ det. 1938] [Syntypus] [*Adioristus/ nitidiventris/ m.*] [DEI/ Eberswalde] [*Adioristus nitidiventris/ Hust./lectotype male/ Morrone des.*] (DEI). Four paralectotypes with the same data (DEI).

Amathynetoides normae,
new species

Figures 105, 107, 109

DIAGNOSIS: This species is recognized by the combination of the following characters: scape gradually widening toward apex; and plate of female sternum 8 with apex entire and short arms.

DESCRIPTION: Holotype female. Integument dark brown. Body vestiture of setalike scales and setae. Frons with fovea. Eyes flat. Rostrum with three slender, dorsal keels. Scrobes subtriangular; suprascrobal keel fine. Antenna with scape gradually widening to-

ward apex, exceeding hind margin of eye when resting in scrobe. *Pronotum* with slightly developed postocular lobes. Metepisternal suture present. Scutellum not prominent. *Elytra* ovate. *Legs* with all tibiae mucronate; with one spur. *Body length* 3.9 mm.

Female Genitalia: Sternum 8 (fig. 105) with very long apodeme (2.2× longer than plate); plate subrectangular, with entire apex and long setae; arms short. Hemisternites (fig. 107) elongate, 8.3× longer than wide; with baculi. Spermatheca (fig. 109) with nodulus.

Male: Unknown.

GEOGRAPHICAL DISTRIBUTION: Known from western Bolivia (fig. 113), in the Punan biogeographic province of Cabrera and Willink (1973).

TYPE MATERIAL: Holotype female with the following labels: [BOLIVIA: Oruro-/ Cochabamba/ Lequepalca/ 24.i.76, 3800 m./ Luis Peña] [H. & A. Howden/ Collection] [*Amathynetoides/ normae* Morrone/ holotype female] (HAHC). One paratype with the following labels: [BOLIVIA: 3500 m./ Yungas de La Paz, Unduavi, 1.i.75] [H. & A. Howden/ Collection] [*Amathynetoides/ normae* Morrone/ paratype] (HAHC). One paratype with the following labels: [BOLIVIA: La Paz/ La Cumbre, 4600 m./ 25.xii.75, L. Peña] [H. & A. Howden/ Collection] [*Amathynetoides/*

normae Morrone/ paratype] (HAHC). One paratype with the following labels: [BOLIVIA: La Paz/ Camino al Illimani/ 25.xii.75 3500 m./ Luis Peña] [H. & A. Howden/ Collection] [*Amathynetoides/ normae* Morrone/ paratype] (MLP).

ETYMOLOGY: I name this species after my friend and colleague Norma B. Díaz, who has encouraged me in many ways.

Amathynetoides palustris
(Kuschel), new combination
Figures 106, 108, 110

Amathynetes palustris Kuschel, 1949: 51.

Puranius palustris; Kuschel, 1955: 288.

Macrostyphlus palustris; Kuschel, 1986: 117; Wibmer and O'Brien, 1986: 117 (checklist).

DIAGNOSIS: This species is recognized by the combination of the following characters: rostrum lacking dorsal keels; scrobes triangular; postocular lobes absent; and metatibiae with two spurs.

REDESCRIPTION: Integument dark brown. Body vestiture lacking scales, only with setae. Frons with fovea. Eyes flat. Rostrum lacking dorsal keels. Scrobes subtriangular; suprascrobal keel fine. Antenna with scape inflated, reaching hind margin of eye when resting in scrobe. *Pronotum* lacking postocular lobes. Metepisternal suture absent. Scutellum not prominent. *Elytra* ovate. *Legs* with pro- and mesotibiae mucronate, metatibiae lacking mucro; pro- and mesotibiae with one spur, metatibiae with two spurs. *Body length* 3.1–6.0 mm.

Female Genitalia: Sternum 8 (fig. 106) with short apodeme (0.7 × longer than plate); plate subelliptical, with open apex and long setae; arms long, reaching apex. Hemisternites (fig. 108) subtriangular, 3.3 × longer than wide; with baculi. Spermatheca (fig. 110) with nodulus.

Male: Unknown.

GEOGRAPHICAL DISTRIBUTION: Known from northern Chile, western Bolivia, and southern Peru (fig. 119). Distribution in Chile lies in the Atacaman entomofaunal region of O'Brien (1971).

TYPE MATERIAL: Holotype female with the following labels: [CHILE. Tarapacá/ Arica-Tacora/ 4800 m/ 6.3.48] [Coll. Kuschel] [HOLOTYPE FEMALE/ *Amathynetes/ pa-*

lustris/ Kuschel] [*Macrostyphlus/ palustris/ (Kuschel)/ det. G. Kuschel/ 1981*] (MHNS). One paratype with the same data (NZAC). One paratype with the following labels: [female] [Tacora/ 4.400 m/ 6.3.48] [Arica/ Kuschel] [PARATIPO] [*Amathynetes/ palustris/ Kuschel/ Kuschel det. 1949*] (USNM).

OTHER MATERIAL EXAMINED: BOLIVIA. LA PAZ: La Cumbre, 12 mi NE La Paz, 4600 m, 7-IV-1978, C. W. and L. O'Brien, 14 (CWOB). PERU. PUNO: Marcapata, Hualahuella, 4750–4850 m, 2-II-1949, G. Kuschel, 2 (NZAC); Puno, 3900 m, XII-1940, Weyrauch, 4 (FIML).

Amathynetoides sparsesetosus
(Hustache), new combination
Figures 111, 112

Adioristus sparsesetosus Hustache, 1938b: 283; Blackwelder, 1947: 812 (checklist); Voss, 1954: 245 (subgenus *Adioristidius*).

Macrostyphlus sparsesetosus; Kuschel, 1986: 117; Wibmer and O'Brien, 1986: 117 (checklist).

DIAGNOSIS: This species is recognized by the combination of the following characters: rostrum lacking dorsal keels; scrobes linear; and scutellum prominent.

REDESCRIPTION: Integument dark brown. Body vestiture lacking scales, only with setae. Frons with fovea. Eyes flat. Rostrum lacking dorsal keels. Scrobes linear; suprascrobal keel fine. Antenna with scape inflated, reaching hind margin of eye when resting in scrobe. *Pronotum* with slightly developed postocular lobes. Metepisternal suture present. Scutellum prominent. *Elytra* ovate. *Legs* with all tibiae mucronate; with one spur. *Body length* 3.1–3.5 mm.

Male Genitalia: Aedeagus (figs. 111, 112) with produced apex, not incised; apodemes slightly longer than tube.

Female: Unknown.

GEOGRAPHICAL DISTRIBUTION: Known from southwestern Bolivia and southern Peru (fig. 113), in the Punan biogeographic province of Cabrera and Willink (1973).

TYPE MATERIAL: Lectotype male (here designated) with the following labels: [Peru] [114.] [Coll. Pape] [Hustache/ det. 1938] [Syntypus] [*Adioristus/ sparsesetosus/ m.*] [DEI/ Eberswalde] [*A. sparsesetosus/ Hust.*] [*Adioristus sparsesetosus/ lectotype male/*

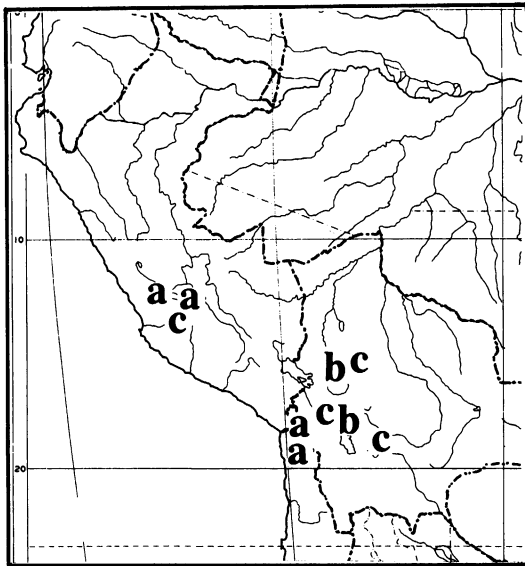

Fig. 113. Geographical distribution of the genus *Amathynetoides*. a, *A. longulus*; b, *A. normae*; c, *A. sparsestosus*.

Morrone des.] (DEI). Three paralectotypes with the same data (DEI).

OTHER MATERIAL EXAMINED: BOLIVIA. ORURO: Lequepalca/Challa, 4200-4300 m, 25-I-1976, L. Peña, 4 (HAHC); Pongo, 4200 m, 25-I-1976, L. Peña, 2 (HAHC); Potosí, E Macha, 4000 m, 29-II-1976, L. E. Peña, 10 (HAHC); Potosí, E Ocuri, 4000 m, 1-III-1976, L. E. Peña, 3 (HAHC); Potosí, 15 km E Ocuri, 4000 m, 1-III-1976, L. E. Peña, 1 (HAHC). LA PAZ: N Calamarca, 24-I-1976, L. E. Peña, 1 (HAHC). PERU. AYACUCHO: 69 km Ayacucho-Castrovirreina Road, 3700 m, 25-IV-1977, J. Mateu, 1 (CWOB).

Amathynetoides sundrianus,
new species
Figures 114-118

DIAGNOSIS: This species is recognized by the incised apex of the aedeagus (character unique in the Rhytirrhinini).

DESCRIPTION: Holotype male. Integument black. Body vestiture lacking scales, only with setae. Frons with fovea. Eyes flat. Rostrum with three slender, dorsal keels. Scrobes subtriangular; suprascrobal keel fine. Antenna with scape inflated, reaching hind margin of

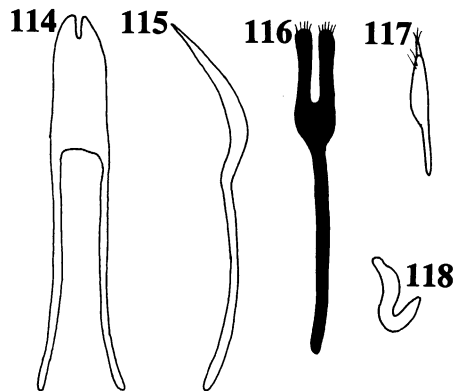

Figs. 114-118. *Amathynetoides sundrianus*, male and female genitalia. 114, Aedeagus, dorsal view; 115, aedeagus, lateral view; 116, female sternum 8; 117, hemisternites; 118, spermatheca.

eye when resting in scrobe. *Pronotum* with slightly developed postocular lobes. *Metepisternal suture* present. *Scutellum* not prominent. *Elytra* ovate. *Legs* with all tibiae mucronate; protibiae with one spur, meso- and metatibiae lacking spurs. *Body length* 5.7 mm.

Male Genitalia: Aedeagus (figs. 114, 115) with apex rounded, incised; apodemes slightly longer than tube.

Female Genitalia: Sternum 8 (fig. 116) with long apodeme (1.6× longer than plate); plate subrectangular, with open apex and short setae; arms long, reaching apex. Hemisternites (fig. 117) elongate, 8.5× longer than wide; with baculi. Spermatheca (fig. 118) with nodulus.

GEOGRAPHICAL DISTRIBUTION: Known from southern Peru (fig. 119).

TYPE MATERIAL: Holotype male with the following labels: [PERU, 4100 m., 20 km./ N. Calca, Calca-/ Masia Road, 20-IV-/ 1977 J. Mateu] [*Amathynetoides/ sundrianus* Morrone/ holotype male] (CWOB). Eight paratypes with the same data (5 CWOB, 3 MLP). Six paratypes with the following labels: [PERU, Andahuaylas-/ Ayacucho Rd., km./ 18,4150 m. "puna"/ 24-IV-1977 J. Mateu] [*Amathynetoides/ sundrianus* Morrone/ paratype] (2 BMNH, 4 CWOB). Six paratypes with the following labels: [PERU, La Raya, Si-/ cuani, km. 189/ Cuzco Road, 4313 m./ Apr. 15, 1977] [J. Mateu] [*Amathynetoides/ sundrianus* Morrone/ paratype] (2

AMNH, 6 CWOB). Four paratypes with the following labels: [PERU, Sachapite,/ 18 km. Huancavelica/ 4000 m. 2 Apr. 1977/ J. Mateu] [*Amathynetoides/ sundrianus* Morrone/ paratype] (CWOB). Two paratypes with the following labels: [Puna bei/ Abancay/ 4000 m/ XII.1947] [WKW/ 5011] [*Puranius/ sp*] [ex-col Weyrauch] [COLECCION/ Fundación M. Lillo/ 4000 S. M. Tucumán/ TUCUMAN-ARGENTINA] [*Amathynetoides/ sundrianus* Morrone/ paratype] (FIML). One paratype with the following labels: [PERU, 3700 m, km. 69/ Ayacucho-Castro/virreina Rd. April/ 25, 1977 J. Mateu] [*Amathynetoides/ sundrianus* Morrone/ paratype] (CWOB).

ETYMOLOGY: From the Anglo-Saxon *sundrian* for separate, referring to the incised apex of the aedeagus.

PURANIUS GERMAIN

Type species: *P. inaequalis* Germain, 1896 (here designated).

Puranius Germain, 1896: 745 (not available, type species not fixed); Schenkling and Marshall, 1931: 5 (cat.); Blackwelder, 1947: 812 (checklist); Kuschel, 1949: 43 (= *Amathynetes* Kuschel), 1955: 288 (reinstated); Cabrera and Wilink, 1973: 89 (biogeogr.); Kuschel, 1986: 116 (= *Macrostyphlus*).

Puranus Germain, 1911: 205 (lapsus).

Reichertia Enderlein, 1912: 31 (type species: *Listroderes exsculpticollis* Enderlein, 1907, by original designation); Schenkling and Marshall, 1931: 13 (cat.); Blackwelder, 1947: 814 (checklist); Kuschel, 1949: 43 (= *Amathynetes*), 1955: 290 (= *Puranius*).

DIAGNOSIS: The species of this genus are recognized by the transverse to strongly transverse pronotum, and the short-ovate elytra.

REDESCRIPTION: Very small to medium-sized (body length 1.9–6.5 mm). Integument rugose, dark brown. Body vestiture generally of subcircular scales and setae. Frons with fovea or lacking it. Eyes medium-sized (as long as rostrum height) to small (as long as half of rostrum height), flat; supraocular sulcus usually present. Rostrum with three dorsal keels or lacking them; squamose. Antenna with funicular articles 3–6 monilliform; club inflated. *Pronotum* (fig. 4) transverse to

strongly transverse; usually not tuberculate; postocular lobes present. Metepisternal suture present or absent. Scutellum not prominent. *Elytra* (fig. 4) short-ovate, with humeri rounded or tuberculate; intervals usually flat; setae usually multifold, strong, straight or slightly curved, blunt. *Legs* with tibiae usually lacking mucro; with one spur or lacking it; usually squamose.

Male Genitalia: Aedeagus usually with produced apex; apodemes slightly longer than tube.

Female Genitalia: Sternum 8 with apodeme usually long (fig. 129); plate subelliptical (fig. 132), subcircular (fig. 134), or subrhomboidal (fig. 133); sclerotized arms usually long, reaching apex. Hemisternites elongate (fig. 137) or subtriangular (fig. 136); baculi and styli usually present. Spermatheca with enlarged ramus (fig. 139); nodulus present (fig. 139) or absent (fig. 140).

BIOLOGY: *Puranius tuberosus*, *P. inaequalis*, *P. australis*, *P. sylvanius*, *P. tuberosus*, and *P. vulgaris* have been found in litter, and *P. championi*, *P. dubius*, *P. nigrinus*, *P. verrucosus*, and *P. exsculpticollis* under stones or wood. Some species have been associated with the following plants: *Ephedra* sp. [Ephedraceae] (*P. vulgaris*); *Senecio smithii* (*P. fasciculiger*) and *Baccharis* sp. (*P. vulgaris*) [Asteraceae]; *Mulinum* sp. [Apiaceae] (*P. elguetai*); *Nothofagus* sp. [Fagaceae] (*P. nigrinus*); and *Poa flabellata* [Poaceae] (*P. championi*). According to Elgueta (1988), species of *Puranius* are found under cushions of *Mulinum* sp. [Apiaceae].

CLADISTICS: The following characters were analyzed:

1. FRONS. [0] with fovea; [1] lacking fovea.
2. FRONS. [0] lacking depression; [1] with depression.
3. EYES. [0] medium-sized (as long as rostrum height); [1] small (as long as half of rostrum height).
4. SUPRAOCULAR SULCUS. [0] absent; [1] present.
5. SUPRASCROBAL KEEL. [0] absent; [1] present, fine; [2] present, strong.
6. ROSTRAL DORSAL KEELS. [0] present, strong; [1] present, slender; [2] absent.

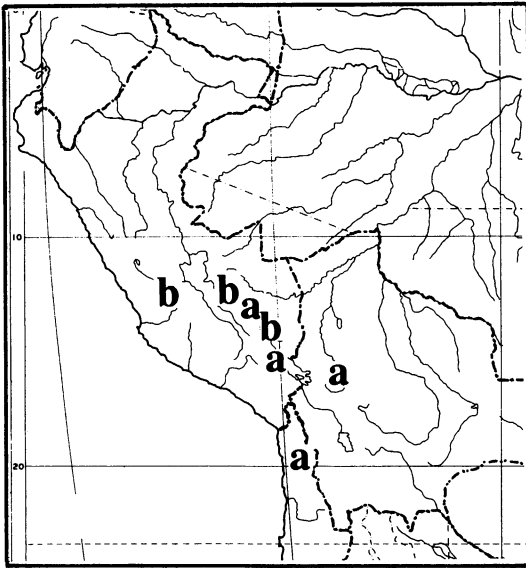

Fig. 119. Geographical distribution of the genus *Amathynetoides*. a, *A. palustris*; b, *A. sundrianus*.

7. SCAPE. [0] exceeding hind margin of eye when resting in scrobe; [1] reaching hind margin of eye when resting in scrobe.
8. SCAPE. [0] gradually widening toward apex; [1] inflated.
9. PRONOTUM. [0] transverse; [1] strongly transverse.
10. PRONOTAL MEDIAN CARINA. [0] absent; [1] present.
11. PRONOTAL MEDIAN SULCUS. [0] absent; [1] present, poorly developed; [2] present, deep.
12. PRONOTAL APICAL IMPRESSION. [0] well developed; [1] poorly developed; [2] absent.
13. POSTOCULAR LOBES. [0] well developed; [1] slightly developed.
14. PRONOTUM. [0] densely squamose; [1] sparsely squamose.
15. METEPISTERNAL SUTURE. [0] present; [1] absent.
16. ELYTRAL HUMERI. [0] rounded; [1] prominent; [2] tuberculate.
17. BASE OF ELYTRAL INTERVAL 3. [0] flat; [1] slightly prominent; [2] tuberculate.
18. ELYTRA. [0] not tuberculate; [1] with small tubercles; [2] with large, conspicuous tubercles.
19. ELYTRAL INTERVALS. [0] flat; [1] slightly convex; [2] strongly convex.
20. ELYTRAL SETAE. [0] simple; [1] bifid; [2] multifid.
21. ELYTRAL SETAE. [0] slender; [1] strong.
22. ELYTRAL SETAE. [0] curved, tapered; [1] straight, blunt.
23. SCALES. [0] subcircular; [1] setalike.
24. SUBCIRCULAR SCALES. [0] thick; [1] thin.
25. PROTIBIAL SPURS. [0] two; [1] one; [2] absent.
26. MESOTIBIAL SPURS. [0] two; [1] one; [2] absent.
27. METATIBIAL SPURS. [0] two; [1] one; [2] absent.
28. METATIBIAL MUCRO. [0] present; [1] absent.
29. LEGS. [0] lacking scales; [1] squamose.
30. STERNITES. [0] lacking scales; [1] squamose.
31. AEDEAGAL APODEMES. [0] slightly longer than tube (fig. 145); [1] shorter than tube (fig. 128); [2] more than twice length of tube (fig. 147).
32. APODEME OF FEMALE STERNUM 8. [0] long (fig. 129); [1] very long (fig. 134).
33. APEX OF PLATE OF FEMALE STERNUM 8. [0] sinuate (fig. 133); [1] entire (fig. 132); [2] open (fig. 129).
34. HEMISTERNITES. [0] long (fig. 137); [1] short (fig. 136).
35. HEMISTERNITES. [0] lacking baculi (fig. 135); [1] with baculi (fig. 137).
36. SPERMATHECAL NODULUS. [0] present (fig. 138); [1] absent (fig. 140).
37. SPERMATHECAL RAMUS. [0] short (fig. 139); [1] enlarged (fig. 152).

The analysis of the data matrix (table 6) led to one cladogram, with 143 steps, a consistency index of 0.32, and a retention index of 0.46. Successive weighting led to one cladogram, with 112 steps, a consistency index improved to 0.52, and a retention index improved to 0.79 (fig. 120). In the cladogram, there is a sequence including *P. midas*, *P. scaber*, and two major clades. One clade in-

TABLE 6
Data Matrix for *Puranius* Germain

	1									2									3																							
	1	2	3	4	5	6	7	8	9	0	1	2	3	4	5	6	7	8	9	0	1	2	3	4	5	6	7	0	1	2	3	4	5	6	7							
<i>Listroderes</i>	0	0	0	0	0	0	0	0	0	0	0	0	0	0	0	0	0	0	0	0	0	0	0	0	0	0	0	0	0	0	0	0	0	0	0							
<i>P. argentinensis</i>	0	0	0	1	1	1	1	0	0	0	0	1	1	1	1	0	0	0	1	1	1	1	1	0	1	0	0	1	1	1	0	1	2	1	0	0	1					
<i>P. australis</i>	1	0	0	1	1	1	0	1	1	0	0	0	1	0	0	2	1	1	1	1	1	1	1	?	0	0	0	1	1	1	?	1	1	1	1	0	?					
<i>P. championi</i>	0	0	0	1	2	0	1	0	0	0	1	0	0	1	0	1	1	1	0	0	1	0	0	0	0	1	0	1	1	0	1	?	?	?	?	?	?					
<i>P. dubius</i>	0	0	0	1	1	1	0	1	0	0	1	0	1	0	1	2	1	1	0	1	1	1	0	1	1	0	0	1	1	1	0	1	0	1	1	1	1					
<i>P. elguetai</i>	1	0	1	1	1	0	0	0	0	1	0	1	0	1	0	1	0	0	1	1	0	0	1	1	0	1	1	1	1	1	1	0	0	2	1	1	1	0				
<i>P. exsculpticollis</i>	1	1	0	0	2	0	1	0	0	0	1	0	0	1	0	1	1	1	0	1	1	1	1	1	?	0	0	0	1	1	1	0	1	2	1	0	0	?				
<i>P. fasciculiger</i>	1	1	0	1	1	1	0	0	0	0	1	0	1	0	0	1	1	1	0	1	1	1	0	1	1	1	0	1	0	0	0	1	1	0	0	2	1	1	1			
<i>P. hispidus</i>	1	1	0	1	1	1	0	1	0	1	1	0	0	1	1	2	1	1	1	1	1	1	0	1	0	1	0	0	1	1	1	1	1	2	1	0	0	?				
<i>P. inaequalis</i>	1	0	1	1	1	2	1	1	1	0	1	0	1	0	1	0	2	1	0	1	1	1	0	0	0	0	0	0	1	1	0	2	1	2	0	1	0	0				
<i>P. midas</i>	0	0	0	1	1	2	0	0	0	0	0	0	0	0	0	0	1	1	0	1	1	0	1	1	0	1	1	0	1	1	0	?	?	?	?	?	?	0				
<i>P. nigrinus</i>	0	0	0	1	1	1	0	0	0	0	2	1	1	1	0	0	0	0	1	1	0	1	0	1	1	0	1	0	0	1	0	0	0	1	2	1	0	0	0			
<i>P. obrienorum</i>	1	0	0	0	2	2	1	0	0	0	1	0	1	1	1	0	1	1	1	1	1	1	1	1	1	0	0	0	1	1	1	1	?	1	0	1	1	0	1			
<i>P. pusillus</i>	1	1	0	1	1	2	1	0	0	0	1	0	0	0	1	1	1	0	0	1	1	1	0	0	1	1	1	0	0	1	1	0	1	1	0	1	0	1	1			
<i>P. scaber</i>	0	0	0	0	1	0	1	0	0	0	0	0	0	0	0	1	0	1	2	0	2	1	1	1	0	1	1	1	1	1	1	0	0	1	2	1	0	0	0			
<i>P. sylvanius</i>	0	0	0	1	1	2	1	0	1	0	0	0	1	0	1	0	1	1	1	0	0	0	0	0	0	0	0	0	0	1	1	1	2	1	2	1	1	0	0			
<i>P. torosus</i>	1	1	0	1	1	1	0	1	0	0	1	0	1	0	1	2	1	2	0	1	1	1	0	1	0	0	0	0	1	1	0	1	0	1	2	1	0	1	0			
<i>P. tothus</i>	0	0	0	1	1	1	0	1	0	0	0	0	0	1	0	1	1	0	0	1	1	0	0	1	1	0	0	0	1	1	0	0	1	0	0	1	2	1	0	0	1	
<i>P. tuberosus</i>	1	0	1	1	1	2	1	0	1	0	0	1	1	0	1	0	1	1	0	1	1	1	0	0	0	0	0	0	1	1	0	2	?	?	?	?	?	?	1			
<i>P. verrucosus</i>	0	0	0	1	1	1	0	1	0	0	2	0	0	0	1	2	1	2	0	1	1	1	0	0	0	0	0	1	1	1	1	0	1	2	1	0	1	1	1			
<i>P. vulgaris</i>	0	0	1	1	1	1	1	1	0	0	1	0	1	0	1	1	1	1	0	1	1	1	0	1	1	1	0	1	1	1	1	1	1	1	1	?	1	0	1	0	1	1

cludes *P. tothus*, *P. nigrinus* plus *P. argentinensis*, *P. australis*, *P. obrienorum*, *P. sylvanius*, *P. tuberosus*, and *P. inaequalis*. The other clade includes *P. championi*, *P. exsculpticollis*, *P. hispidus*, *P. fasciculiger*, *P. pusillus*, *P. elguetai*, *P. vulgaris*, *P. dubius*, *P. torosus*, and *P. verrucosus*.

GEOGRAPHICAL DISTRIBUTION: Species of *Puranius* are distributed from southern Chile and Argentina to Bolivia and Peru (figs. 141, 153, 164, 170, 191, 202), in the Subantarctic and Insular provinces (Subantarctic dominion) and Central Chilean and Punan provinces (Andeanpatagonian dominion) of Cabrera and Willink (1973).

Puranius is part of a central-southern generalized track shared with *Adioristidius*, *Amathynetoides*, and *Listroderes* Schoenherr (Morrone, 1993b, c, in press a, b). This track represents an extension of the one I have previously delimited (Morrone, 1993a), based on *Philippius* Germain (Morrone, 1990), *Falklandius* Enderlein (Morrone, 1992a), *Lanteriella* Morrone (Morrone, 1992a), *Falklandiellus* Kuschel (Morrone, in press c), *Antarctobius* Fairmaire (Morrone, 1992b), *Trachodema* Blanchard (Morrone, 1992c),

and *Haversiella* Schweiger. In southern Peru, both central-southern and northern tracks are present, identifying the area as a node.

Replacing the relevant areas of endemism (fig. 121) and reducing widespread taxa, the area cladograms of *Puranius*, *Adioristidius*, and *Listroderes* are obtained (figs. 122–124). *Amathynetoides*, present in only one area, is uninformative at this level. Component analysis under assumption 2 produced three general area cladograms (assumptions 0 and 1 gave no result), of which the Nelson consensus tree (fig. 125) is identical to the only cladogram obtained with TAS (data matrix in table 7). BPA (data matrix in table 8) produced two different general area cladograms. One of them had 54 items of error (fig. 126), the other 60, while the former three general area cladograms had 70, 78, 78, respectively. According to the chosen general area cladogram (fig. 126):

- (1) A first vicariant event separated the Punan biogeographic province (D) from the rest;
- (2) a second event fragmented Central Chile (B) from the Subantarctic dominion (A) plus northwestern Argentina (C);

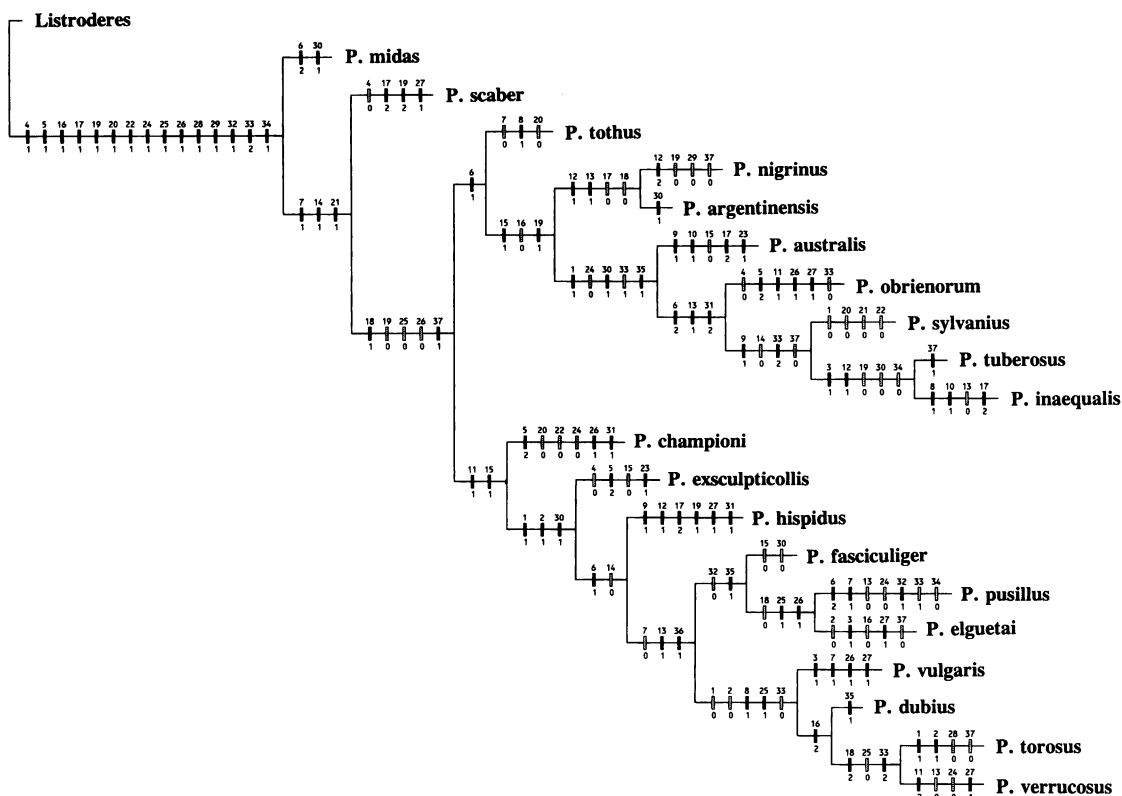

Fig. 120. Cladogram of the species of the genus *Puranius*.

(3) the last event partitioned the Subantarctic dominion (A) from northwestern Argentina (C).

For the separation of areas within the Subantarctic dominion, see Morrone (1993a).

KEY TO SPECIES OF
PURANIUS GERMAIN

- 1. Body vestiture of setalike scales and setae 2
- 1a. Body vestiture of subcircular scales and setae 3
- 2. Frons lacking depression; supraocular sulcus present; rostral dorsal keels slender; pronotum with median carina; < 4.5 mm body length; central and southern Chile and southern Argentina. *P. australis* Germain
- 2a. Frons with depression; supraocular sulcus absent; rostral dorsal keels strong; pronotum with median sulcus; > 4.6 mm body length; Falkland Islands *P. exsculpticollis* (Enderlein)
- 3. Pronotum strongly transverse 4
- 3a. Pronotum transverse 7
- 4. Frons with depression; metatibiae with one spur; central and southern Chile *P. hispidus* (Germain)
- 4a. Frons lacking depression; metatibiae with two spurs 5
- 5. Frons with fovea; eyes medium-sized (as long as rostrum height); elytra with small declivital tubercle on interval 3, and setae slender, curved, tapered; southern Chile and southern Argentina *P. vulgaris*, n. sp.
- 5a. Frons lacking fovea; eyes small (as long as half of rostrum height); elytra lacking declivital tubercle on interval 3, and setae strong, straight or slightly curved, blunt 6
- 6. Scrobes subtriangular; scape gradually widening toward apex; pronotum lacking median carina and lateral impressions, post-ocular lobes slightly developed; elytra with base of interval 3 slightly prominent; tibial setae short; central Chile *P. tuberosus* Germain
- 6a. Scrobes linear; scape inflated; pronotum with

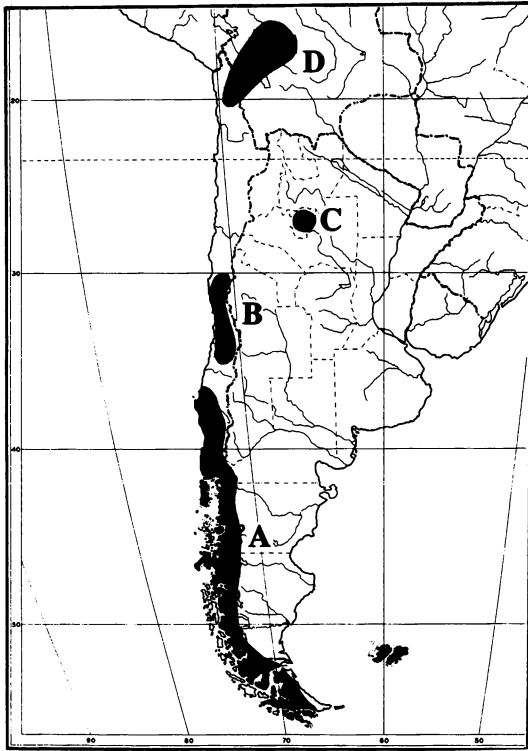
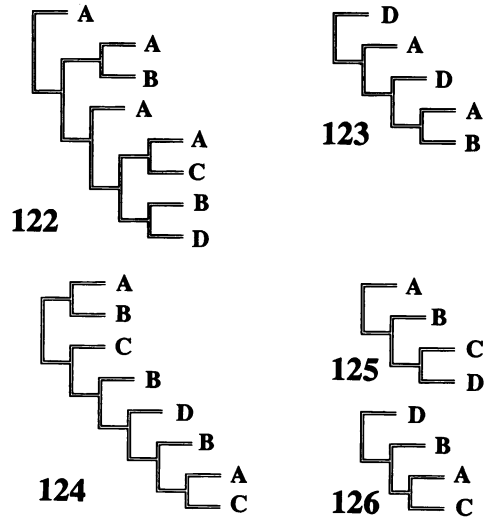

Fig. 121. Areas of endemism relevant to the analysis of *Puranius*, *Adioristidius*, and *Listroderes*. A = Subantarctic dominion; B = Central Chile; C = northwestern Argentina; D = Puna province.



Figs. 122–126. Area cladograms. 122, *Puranius*; 123, *Adioristidius*; 124, *Listroderes*; 125, Nelson consensus of the three general area cladograms obtained by component analysis (assumption 2) and the single cladogram obtained with TAS; 126, one of the two general area cladograms obtained with BPA. Areas A–D as in figure 121.

median carina and two, subcircular, lateral impressions, postocular lobes well developed; elytra with base of interval 3 tuberculate; tibial setae long; central Chile ... *P. inaequalis* Germain

- 7. Metepisternal suture present 8
- 7a. Metepisternal suture absent 11
- 8. Scrobes linear; scape inflated; elytra with apical dentiform projection, setae simple; southern Chile *P. tothus*, n. sp.

- 8a. Scrobes subtriangular; scape gradually widening toward apex; elytra lacking dentiform projection, setae multifid 9
- 9. Supraocular sulcus absent; elytra with strongly convex intervals, and base of interval 3 tuberculate; Falkland Islands ... *P. scaber* (Enderlein)
- 9a. Supraocular sulcus present; elytra with slightly convex or flat intervals, and base of interval 3 slightly prominent 10
- 10. Frons with depression; rostrum with three dorsal keels; pronotum with median sulcus; southern Chile *P. fasciculiger* (Blanchard)
- 10a. Frons with fovea; rostrum lacking dorsal keels; pronotum lacking median sulcus; Chile *P. midas*, n. sp.

TABLE 7
Data Matrix for BPA for *Puranius*, *Adioristidius*, and *Listroderes*

	1										2										3									
	1	2	3	4	5	6	7	8	9	0	1	2	3	4	5	6	7	8	9	0	1	2	3	4	5	6	7	8	9	0
out	0	0	0	0	0	0	0	0	0	0	0	0	0	0	0	0	0	0	0	0	0	0	0	0	0	0	0	0	0	0
A	1	1	0	1	1	0	0	0	1	1	0	1	1	1	1	0	1	0	1	0	1	0	1	1	1	1	0	0	0	0
B	0	0	1	0	0	0	1	0	1	0	1	1	1	1	1	0	0	0	0	1	1	1	1	1	0	1	0	1	0	1
C	0	0	0	0	0	1	0	0	0	1	0	1	1	1	1	?	?	?	?	?	?	?	?	?	0	0	1	0	0	0
D	0	0	0	0	0	0	1	0	0	1	1	1	1	1	1	1	0	1	0	0	0	1	1	1	0	0	0	0	1	0

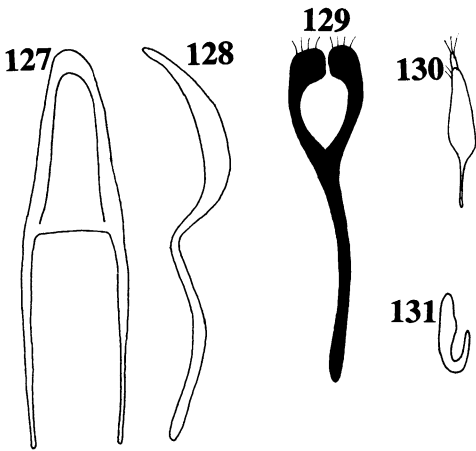

Figs. 127–131. *Puranius argentinensis*, male and female genitalia. 127, Aedeagus, dorsal view; 128, aedeagus, lateral view; 129, female sternum; 130, hemisternites; 131, spermatheca.

- 11. Elytra tuberculate 12
- 11a. Elytra not tuberculate 17
- 12. Frons lacking fovea or depression; supraocular sulcus absent; pronotum tuberculate; elytra with rounded humeri; Bolivia and Peru *P. obrienorum*, n. sp.
- 12a. Frons with fovea or depression; supraocular sulcus present; pronotum not tuberculate; elytra with prominent or tuberculate humeri 13
- 13. Rostral dorsal keels strong; pronotum sparsely squamose; elytral setae simple, curved, tapered; Falkland Islands *P. championi* (Kuschel)
- 13a. Rostral dorsal keels slender; pronotum densely squamose; elytral setae multifid, straight or slightly curved, blunt 14
- 14. Elytra with declivital tubercle on interval 3 15
- 14a. Elytra lacking declivital tubercle on interval 3 16
- 15. Scrobes linear; pronotum with poorly developed median sulcus, postocular lobes slightly developed; metatibiae with two spurs; central Chile ... *P. torosus*, n. sp.
- 15a. Scrobes subtriangular; pronotum with deep median sulcus, postocular lobes well developed; metatibiae with one spur; central Chile *P. verrucosus* (Germain)
- 16. Eyes medium-sized (as long as rostrum height); pro- and mesotibiae with two spurs; > 2.6 mm body length; central Chile *P. dubius* (Germain)
- 16a. Eyes small (as long as half of rostrum height);

TABLE 8
Data Matrix for TAS for *Puranius*, *Adioristidius*, and *Listroderes*

	1												
	1	2	3	4	5	6	7	8	9	0	1	2	
out	0	0	0	0	0	0	0	0	0	0	0	0	0
A	0	0	0	1	1	?	1	1	?	1	1	?	
B	1	1	?	0	0	0	1	?	1	1	?	1	
C	1	?	1	1	?	1	0	0	0	?	1	1	
D	?	1	1	?	1	1	?	1	1	0	0	0	
repl.	8	8	5	7	4	4	5	1	3	6	2	1	

- pro- and mesotibiae with one spur; < 2.5 mm body length; central Chile *P. sylvanius*, n. sp.
- 17. Frons with fovea; pronotum lacking median sulcus, sparsely squamose; elytra with base of interval 3 flat; mesotibiae with one spur 18
- 17a. Frons lacking fovea; pronotum with poorly developed median sulcus, densely squamose; elytra with base of interval 3 slightly prominent; mesotibiae with two spurs .. 19
- 18. Scrobes subtriangular; elytra with flat intervals; legs and sternites lacking scales; > 3.5 mm body length; southern Chile and southern Argentina *P. nigrinus* (Fairmaire)
- 18a. Scrobes linear; elytra with slightly convex intervals; legs and sternites squamose; < 3.4 mm body length; northwestern Argentina *P. argentinensis*, n. sp.
- 19. Frons lacking depression; eyes small (as long as half of rostrum height); rostrum with three dorsal keels; scape exceeding hind margin of eye when resting in scrobe; elytra with rounded humeri; tibiae with long setae; > 2.5 mm body length; central Chile. *P. elguetai*, n. sp.
- 19a. Frons with depression; eyes medium-sized (as long as rostrum height); rostrum lacking dorsal keels; scape reaching hind margin of eye when resting in scrobe; elytra with prominent humeri; tibiae with short setae; < 2.4 mm body length; central Chile *P. pusillus*, n. sp.

Puranius argentinensis,
new species
Figures 127–131

DIAGNOSIS: This species is recognized by the combination of the following characters:

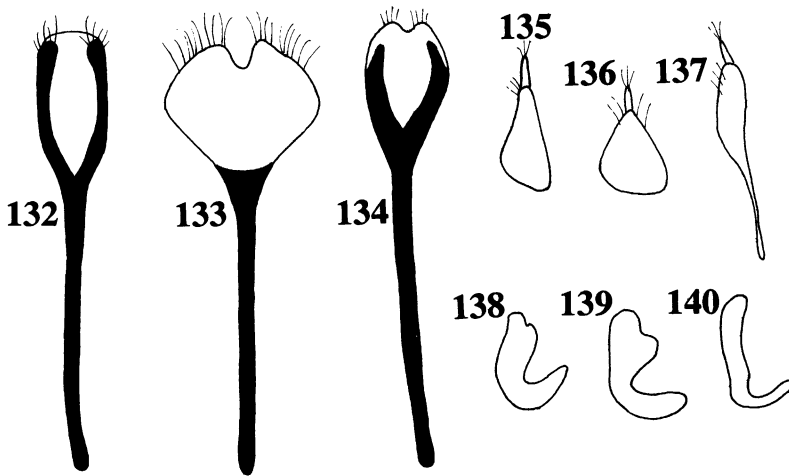

Figs. 132–140. Female genitalia. 132–139, Female sternum 8; 135–137, hemisternites; 138–140, spermatheca; 132, 135, 138, *P. australis*; 133, 136, 139, *P. obrienorum*; 134, 137, 140, *P. vulgaris*.

scrobes linear; elytral intervals convex; and apex of aedeagus rounded.

DESCRIPTION: Holotype male. Body vestiture of thin, subcircular scales, and setae. Frons with fovea. Eyes medium-sized (as long as rostrum height); supraocular sulcus present. Rostrum with three slender, dorsal keels. Scrobes linear; suprascrobal keel fine. Antenna with scape gradually widening toward apex, reaching hind margin of eye when resting in scrobe. *Pronotum* transverse; apical impression poorly developed; median carina, sulcus, and subcircular, lateral impressions absent; not tuberculate; postocular lobes slightly developed; sparsely squamose. Metepisternal suture absent. *Elytra* with slightly convex intervals; not tuberculate; base of interval 3 flat; humeri rounded; declivital tubercle on interval 3 absent; setae multifid, strong, straight or slightly curved, blunt. *Sternites* squamose. *Legs* with all tibiae lacking mucro; with two spurs; squamose and with short setae. *Body length* 3.0 mm.

Male Genitalia: Aedeagus (figs. 127, 128) with rounded apex; apical hairs absent; apodemes slightly longer than tube.

Female Genitalia: Sternum 8 (fig. 129) with very long apodeme ($1.7\times$ longer than plate); plate subelliptical, with open apex and long setae; arms long, reaching apex. Hemisternites (fig. 130) elongate, $5.0\times$ longer than wide; with baculi; styli present. Spermatheca

(fig. 131) with enlarged ramus; nodulus present.

GEOGRAPHICAL DISTRIBUTION: Known only from the type locality in northwestern Argentina (fig. 141).

TYPE MATERIAL: Holotype male with the following labels: [Tucumán/ la Ciénaga/ 3.300 m] [*Listr./ bosqi*/ K 44/ Kschl. i. i.] [*Puranius/ argentinensis* Morrone/ holotype male] (MLP). Seven paratypes with the same data (2 AMNH, 2 BMNH, 3 MLP).

ETYMOLOGY: This species is named after the country of Argentina.

Puranius australis Germain

Figures 4, 132, 135, 138

Puranius australis Germain, 1896: 747, 1911: 205 (list); Kolbe, 1907: 101 (cat.); Schenkl and Marshall, 1931: 5 (cat.); Blackwelder, 1947: 812 (checklist); Kuschel, 1955: 288.

Amathynetes australis; Kuschel, 1949: 45.

Macrostyphlus australis; Kuschel, 1986: 116; Wibmer and O'Brien, 1986: 116 (checklist); Elgueta and Morrone, 1992: 133 (types).

DIAGNOSIS: This species is recognized by the combination of the following characters: frons lacking fovea; pronotum strongly transverse; elytra with intervals slightly convex and base of interval 3 tuberculate; hemisternites lacking baculi; and spermatheca with short ramus.



Fig. 141. Geographical distribution of the genus *Puranius*. a, *P. argentinensis*; b, *P. australis*; c, *P. championi*.

REDESCRIPTION: Body vestiture of setalike scales and setae. Frons lacking fovea. Eyes medium-sized (as long as rostrum height); supraocular sulcus present. Rostrum with three slender, dorsal keels. Scrobes subtriangular; suprascrobal keel fine. Antenna with scape gradually widening toward apex, reaching hind margin of eye when resting in scrobe. *Pronotum* (fig. 4) strongly transverse; apical impression well developed; median carina present. sulcus poorly developed; subcircular, lateral impressions absent; not tuberculate; postocular lobes well developed; sparsely squamose. Metepisternal suture present. *Elytra* (fig. 4) with slightly convex intervals; with small tubercles; base of interval 3 tuberculate; humeri rounded; declivital tubercle on interval 3 large; setae multifid, strong, straight or slightly curved, blunt. *Sternites* squamose. *Legs* with all tibiae lacking mucro; with two spurs; squamose and with short setae. *Body length* 3.2–4.0 mm.

Female Genitalia: Sternum 8 (fig. 132) with

very long apodeme ($1.7 \times$ longer than plate); plate subelliptical, with entire apex and long setae; arms long, reaching apex. Hemisternites (fig. 135) subtriangular, $2.2 \times$ longer than wide; lacking baculi; styli present. Spermatheca (fig. 138) with short ramus; nodulus present.

Male: Unknown.

GEOGRAPHICAL DISTRIBUTION: Known from central and southern Chile, and southern Argentina (fig. 141). Distribution in Chile lies in the Coquimban, Santiagan, and Valdivian entomofaunal regions of O'Brien (1971). Germain (1896) erroneously reported this species from Magallanes (Kuschel, in litt.).

TYPE MATERIAL: Lectotype female with the following labels: [122] [holotype ♀/ *Puranius/ australis/* Germain] [*australis/ P. G.*] [*Puranius/ australis/* Germain/ det. G. Kuschel/ 1981] [Lectotipo ♀/ *Puranius australis/* Elgueta & Morrone des. 1992] (MHNS). Three paralectotypes with the same data (2 MHNS, 1 NZAC).

OTHER MATERIAL EXAMINED: ARGENTINA. CHUBUT: Lago Puelo, 13-VII-1963, A. Kovacs, 1 (AMNH). CHILE. CAUTIN: Temuco, 5-III-1945, E. A. Chapin, 1 (USNM). CHOAPA: 10 km S Zapallar, 8-VIII-1968, "berlese funnel," C. W. O'Brien, 5 (CWOB). LLANQUIHUE: Puerto Montt, 1-II-1974, A. Cisternas, 1 (MHNS). MALLECO: Malalcahuello, Ing. Franz, 1 (NZAC). VALPARAISO: 13 km E Puchuncaví, 1600 ft, "berlese funnel," 8-VIII-1968, C. W. O'Brien, 1 (CWOB).

Puranius championi (Kuschel)

Figures 142, 143

Amathynetes championi Kuschel, 1952: 136 (replacement name for *Reichertia exsculpticollis* Champion, not Enderlein); Ringuelet, 1955: 434 (biogeogr.); Schweiger, 1958: 42 (biogeogr.); Robinson, 1984: 7 (list).

Reichertia exsculpticollis Champion, 1918: 182; Kuschel, 1952: 136 (misidentification, in part, not Enderlein, 1907).

Puranius championi; Kuschel, 1955: 288.

Macrostyphlus championi; Kuschel, 1986: 116; Wibmer and O'Brien, 1986: 116 (checklist).

Reichertia championi; Voisin, 1987: 94 (biogeogr.).

DIAGNOSIS: This species is recognized by

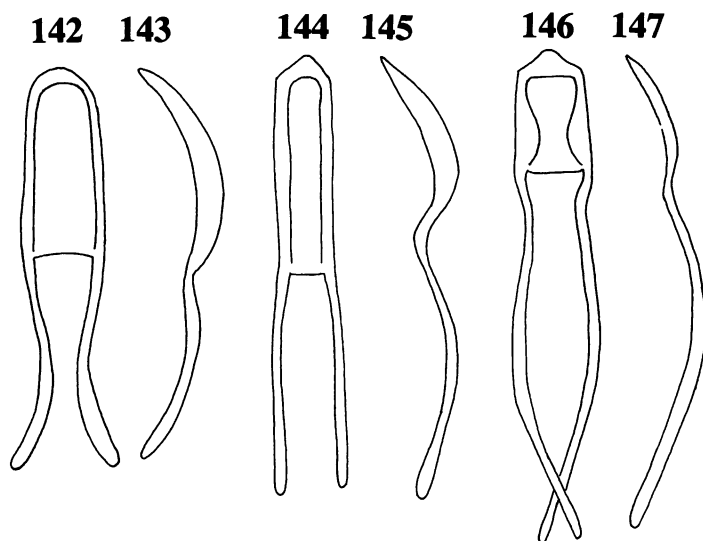

Figs. 142–147. Male genitalia. 142, 144, 146, Aedeagus, dorsal view; 143, 145, 147, aedeagus, lateral view; 142, 143, *P. championi*; 144, 145, *P. midas*; 146, 147, *P. tuberosus*.

the combination of the following characters: supraocular sulcus present; metepisternal suture absent; elytral setae simple, curved, tapered; mesotibiae with one spur; and aedeagus with rounded apex and apodemes shorter than tube.

REDESCRIPTION: Body vestiture of thick, subcircular scales, and setae. Frons with fovea. Eyes medium-sized (as long as rostrum height); supraocular sulcus present. Rostrum with three strong, dorsal keels. Scrobes subtriangular; suprascrobal keel strongly developed. Antenna with scape gradually widening toward apex, reaching hind margin of eye when resting in scrobe. *Pronotum* transverse; apical impression well developed; median carina and subcircular, lateral impressions absent; sulcus poorly developed; not tuberculate; postocular lobes well developed; sparsely squamose. Metepisternal suture absent. *Elytra* with flat intervals; with small tubercles; base of interval 3 slightly prominent; humeri prominent; declivital tubercle on interval 3 small; setae simple, strong, curved, tapered. *Sternites* lacking scales. *Legs* with all tibiae lacking mucro; pro- and metatibia with two spurs, mesotibia with one spur; squamose and with short setae. *Body length* 5.6–6.1 mm.

Male Genitalia: Aedeagus (figs. 142, 143) with rounded apex; apical hairs absent; apodemes shorter than tube.

Female: Unknown.

GEOGRAPHICAL DISTRIBUTION: Known from the Falkland Islands (fig. 141), in the Insular province (Subantarctic dominion) of Cabrera and Willink (1973).

TYPE MATERIAL: Holotype male with the following labels: [Falkland Is./ 73-22.] [Ann. & Mag. 1918/ *Reichertia/ exsculpticollis*, End.] [Holotype] [*Amathynetes/ championi/ Kschl./ Kuschel* 1950] (BMNH). Two paratypes with the same labels (1 BMNH, 1 NZAC).

OTHER MATERIAL EXAMINED: ARGENTINA. FALKLAND ISLANDS: Kidney Island, “under plank in tussock,” 30-XI-1961, M. Holdgate, 3 (CWOB), 15-III-1963, D. Davidson, 2 (CWOB); Port Stanley, “common,” “under stones,” D. Davidson, 1 (CWOB); Rabbit Cove, “from under stones,” 27-I-1949, G. J. Lockley, 1 (CWOB); without precise data, 1968, 1 (NZAC).

Puranius dubius (Germain)

Figures 148–152

- Listroderes dubius* Germain, 1896: 730, 1911: 205 (list); Schenkling and Marshall, 1931: 7 (cat.); Blackwelder, 1947: 813 (checklist).
Amathynetes dubius; Kuschel, 1949: 45.
Puranius dubius; Kuschel, 1955: 288.
Macrostyphlus dubius; Kuschel, 1986: 116; Wib-

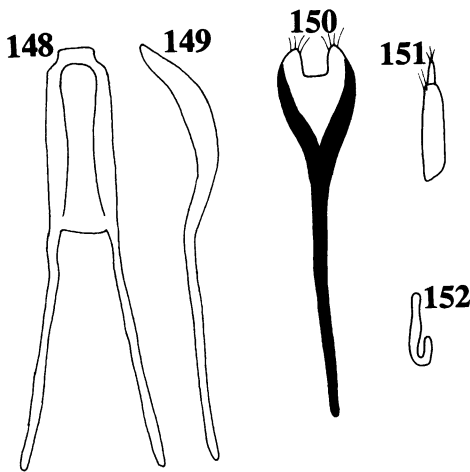

Figs. 148–152. *Puranius dubius*, male and female genitalia. 148, Aedeagus, dorsal view; 149, aedeagus, lateral view; 150, female sternum 8; 151, hemisternites; 152, spermatheca.

mer and O'Brien, 1986: 116 (checklist); Elgueta and Morrone, 1992: 135 (types).

DIAGNOSIS: This species is recognized by the combination of the following characters: scape inflated; elytra with tuberculate humeri; and aedeagus with rounded apex.

REDESCRIPTION: Body vestiture of thin, subcircular scales, and setae. Frons with fovea. Eyes medium-sized (as long as rostrum height); supraocular sulcus present. Rostrum with three slender, dorsal keels. Scrobes subtriangular; suprascrobal keel fine. Antenna with scape inflated, exceeding hind margin of eye when resting in scrobe. *Pronotum* transverse; apical impression well developed; median carina and subcircular, lateral impressions absent; sulcus poorly developed; not tuberculate; postocular lobes slightly developed; densely squamose. Metepisternal suture present. *Elytra* with flat intervals; with small tubercles; base of interval 3 slightly prominent; humeri tuberculate; declivital tubercle on interval 3 absent; setae multifid, strong, straight or slightly curved, blunt. *Sternites* squamose. *Legs* with all tibiae lacking mucro; protibia with one spur, meso- and metatibiae lacking spurs; squamose and with short setae. *Body length* 3.0–3.9 mm.

Male Genitalia: Aedeagus (figs. 148, 149)

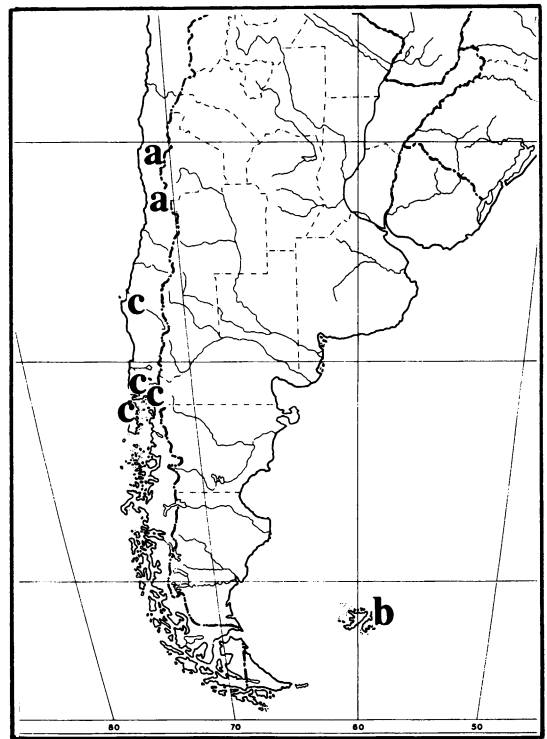

Fig. 153. Geographical distribution of the genus *Puranius*. a, *P. dubius*; b, *P. exsculpticollis*; c, *P. fasciculiger*.

with rounded apex; apical hairs absent; apodemes slightly longer than tube.

Female Genitalia: Sternum 8 (fig. 150) with very long apodeme ($2.3\times$ longer than plate); plate subelliptical, with sinuate apex and long setae; arms long, reaching apex. Hemisternites (fig. 151) elongate, $4.7\times$ longer than wide; lacking baculi; styli present. Spermatheca (fig. 152) with enlarged ramus; nodulus absent.

GEOGRAPHICAL DISTRIBUTION: Known from central Chile (fig. 153), in the Coquimban entomofaunal region of O'Brien (1971).

TYPE MATERIAL: Lectotype male with the following labels: [Coqbo] [325] [holotype δ / *dubius*/ Germain] [*dubius*/ P. G.] [*Puranius/dubius*/ (Germain)/ det. G. Kuschel/ 1981] [Lectotipo δ / *Listroderes dubius*/ Elgueta & Morrone des. 1992] (MHNS). Three paralectotypes with the same data (2 MHNS, 1 NZAC).

OTHER MATERIAL EXAMINED: CHILE. CHACABUCO: Rungue, "under stones," 19-XI-1967, J. Apablaza and C. W. O'Brien, 1 (CWOB). Choapá: 12 km N Huentelauquén, 14-XII-1967, L. and C. W. O'Brien, 3 (CWOB); Los Vilos, "under stones," 13-XII-1967, L. and C. W. O'Brien, 2 (CWOB); 2 km N Los Vilos, 50 ft, "under stones," 12-XI-1967, L. and C. W. O'Brien, 6 (CWOB). SANTIAGO: 3 km E El Manzano, 8-XII-1968, D. Correa, 2 (CWOB); La Ollita, Cantillana, 2000 m, 1/8-XII-1969, L. E. Peña, 1 (MHNS). VALPARAISO: LloLleo, 23-XI-1968, C. W. and L. O'Brien, 6 (CWOB); 13 km E Puchuncaví, 1600 ft, "at night," 18-IX-1967, L. and C. W. O'Brien, 1 (CWOB). Without precise data: 1 (NZAC).

Puranius elguetai, new species

Figures 154–158

DIAGNOSIS: This species is recognized by the combination of the following characters: frons lacking fovea; elytra with rounded humeri; tibial setae short; female sternum 8 with long apodeme and apex of plate open; and spermatheca with short ramus.

DESCRIPTION: Holotype male. Body vestiture of thin, subcircular scales and setae. Frons lacking fovea. Eyes small (as long as half of rostrum height); supraocular sulcus present. Rostrum with three slender, dorsal keels. Scrobes subtriangular; suprascrobal keel fine. Antenna with scape gradually widening toward apex, exceeding hind margin of eye when resting in scrobe. *Pronotum* transverse; apical impression well developed; median carina and subcircular, lateral impressions absent; sulcus poorly developed; not tuberculate; postocular lobes slightly developed; densely squamose. Metepisternal suture absent. *Elytra* with flat intervals; not tuberculate; base of interval 3 slightly prominent; humeri rounded; declivital tubercle on interval 3 absent; setae multifid, strong, straight or slightly curved, blunt. *Sternites* squamose. *Legs* with all tibiae lacking mucro; with one spur; squamose and with long setae. *Body length* 2.9 mm.

Male Genitalia: Aedeagus (figs. 154, 155) with produced apex; apical hairs absent; apodemes slightly longer than tube.

Female Genitalia: Sternum 8 (fig. 156) with

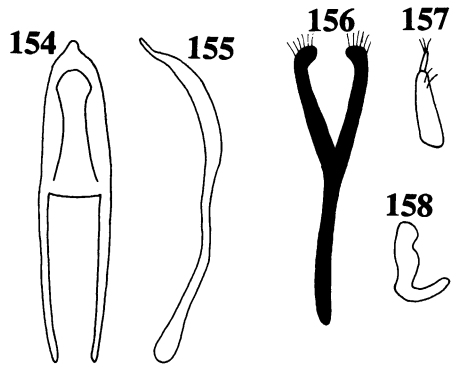

Figs. 154–158. *Puranius elguetai*, male and female genitalia. 154, Aedeagus, dorsal view; 155, aedeagus, lateral view; 156, female sternum 8; 157, hemisternites; 158, spermatheca.

long apodeme (1.1 × longer than plate); plate subeliptical, with open apex and long setae; arms long, reaching apex. Hemisternites (fig. 157) elongate, 3.6 × longer than wide; lacking baculi; styli present. Spermatheca (fig. 158) with short ramus; nodulus absent.

GEOGRAPHICAL DISTRIBUTION: Known from central Chile (fig. 164), in the Santiagan entomofaunal region of O'Brien (1971).

TYPE MATERIAL: Holotype male with the following labels: [Chile Santiago/ Co Roble Alto/ 7,8.12.1980/ Coll: M. Elgueta/ bajo *Mulinum*] [*Puranius*/ sp. 2/ det. M. Elgueta 1982] [*Puranius*/ *elguetai* Morrone/ holotype male] (MHNS). Two paratypes with the same data except 17/18.12.1980 (1 AMNH, 1 MHNS). One paratype with the same data except 28.12.1983 (MHNS). Three paratypes with the following labels: [Chile Santiago/ Cerro El Roble/ 22.11.1982/ Coll. M. Elgueta] [*Puranius*/ *elguetai* Morrone/ paratype] (1 MHNS, 2 MLP).

OTHER MATERIAL EXAMINED: CHILE. PE-TORCA: Cerro Piedra del Gaucho, 20-21.02.1981, M. Elgueta, 1 (MHNS). VALPARAISO: Concón, 15-VIII-1970, M. Pino, 1 (MHNS).

ETYMOLOGY: I name this species after my friend and colleague Mario Elgueta.

Puranius exsculpticollis
(Enderlein)

Figures 159–163

Listroderes exsculpticollis Enderlein, 1907: 60; Kolbe, 1907: 105 (cat.).

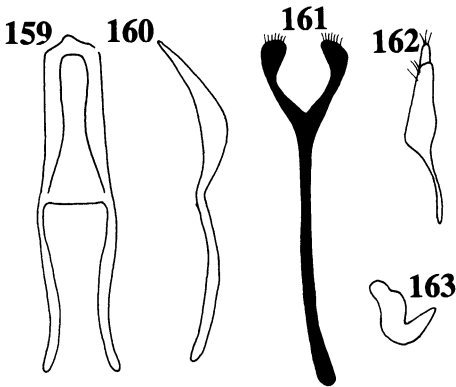

Figs. 159–163. *Puranius exsculpticollis*, male and female genitalia. 159, Aedeagus, dorsal view; 160, aedeagus, lateral view; 161, female sternum 8; 162, hemisternites; 163, spermatheca.

Listroderes insquameus Enderlein, 1907: 62; Kolbe, 1907: 105 (cat.).

Reichertia exsculpticollis; Enderlein, 1912: 32; Schenkling and Marshall, 1931: 13 (cat.); Blackwelder, 1947: 814 (checklist).

Reichertia insquamea; Enderlein, 1912: 33; Champion, 1918: 183 (= *R. exsculpticollis* ?); Schenkling and Marshall, 1931: 13 (cat.).

Amathynetes exsculpticollis; Kuschel, 1949: 45, 1952: 136; Ringuelet, 1955: 434 (biogeogr.); Schweiger, 1958: 42 (biogeogr.); Robinson, 1984: 7 (list).

Amathynetes insquameus; Kuschel, 1949: 45, 1952: 136 (= *A. exsculpticollis*).

Puranius exsculpticollis; Kuschel, 1955: 288.

Macrostyphlus exsculpticollis; Kuschel, 1986: 116; Wibmer and O'Brien, 1986: 116 (checklist).

DIAGNOSIS: This species is recognized by the combination of body vestiture of setalike scales, and frons with depression.

REDESCRIPTION: Body vestiture of setalike scales and setae. Frons with depression. Eyes medium-sized (as long as rostrum height); supraocular sulcus absent. Rostrum with three strong, dorsal keels. Scrobes subtriangular; suprascrobal keel strongly developed. Antenna with scape gradually widening toward apex, reaching hind margin of eye when resting in scrobe. *Pronotum* transverse; apical impression well developed; median carina and subcircular, lateral impressions absent; sulcus poorly developed; not tuberculate; postocular lobes well developed; sparsely squamose. Metepisternal suture present. *Elytra* with flat

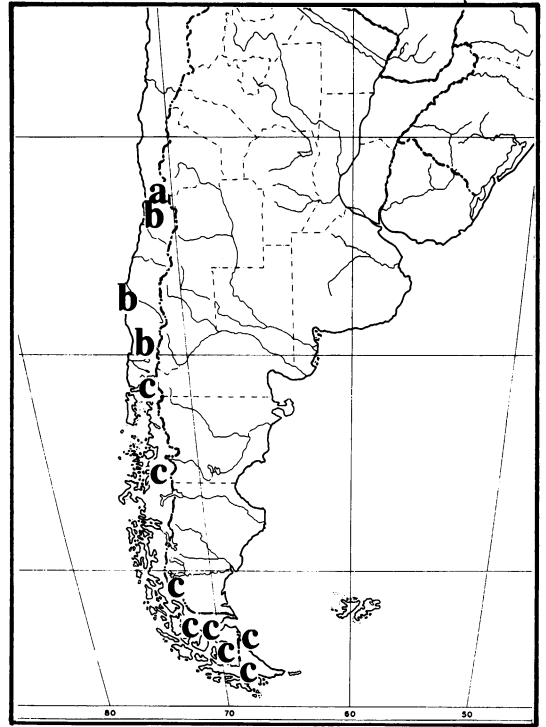

Fig. 164. Geographical distribution of the genus *Puranius*. a, *P. elguetai*; b, *P. hispidus*; c, *P. nigrinus*.

intervals; with small tubercles; base of interval 3 slightly prominent; humeri prominent; declivital tubercle on interval 3 small; setae multifid, strong, straight or slightly curved, blunt. *Sternites* squamose. *Legs* with all tibiae lacking mucro; with two spurs; squamose and with short setae. *Body length* 5.1–6.5 mm.

Male Genitalia: Aedeagus (figs. 159, 160) with produced apex; apical hairs absent; apodemes slightly longer than tube.

Female Genitalia: Sternum 8 (fig. 161) with very long apodeme ($2.8\times$ longer than plate); plate subcircular, with open apex and short setae; arms long, reaching apex. Hemisternites (fig. 162) elongate, $5.8\times$ longer than wide; with baculi; styli present. Spermatheca (fig. 163) with short ramus; nodulus present.

GEOGRAPHICAL DISTRIBUTION: Known from the Falkland Islands (fig. 153), in the Insular province (Subantarctic dominion) of Cabrera and Willink (1973).

MATERIAL EXAMINED: ARGENTINA.

FALKLAND ISLANDS: Fox Bay, "unter Steinen," 23-III-1902, 1 (NZAC); Port Stanley, 8-XI-1909, A. M. Reed, 1 (BMNH), "under cow dung," 21-X-1962, D. Davidson, 1 (BMNH).

Puranius fasciculiger

(Blanchard)

Figures 165–169

Listroderes fasciculiger Blanchard, 1851: 342; Schenkling and Marshall, 1931: 7 (cat.); Blackwelder, 1947: 813 (checklist).

Listroderes sobrinus Germain, 1896: 732, 1911: 205 (list); Kolbe, 1907: 104 (cat.); Schenkling and Marshall, 1931: 10 (cat.); Blackwelder, 1947: 813 (checklist).

Listroderes frigidus Germain, 1896: 734, 1911: 205 (list); Kolbe, 1907: 104 (cat.); Schenkling and Marshall, 1931: 8 (cat.); Blackwelder, 1947: 813 (checklist).

Amathynetes frigidus; Kuschel, 1949: 45.

Amathynetes sobrinus; Kuschel, 1949: 45.

Puranius fasciculiger; Kuschel, 1955: 290.

Puranius frigidus; Kuschel, 1955: 290 (= *P. fasciculiger*).

Puranius sobrinus; Kuschel, 1955: 288, 1986: 117 (= *Macrostyphlus fasciculiger*).

Macrostyphlus fasciculiger; Kuschel, 1986: 117; Wibmer and O'Brien, 1986: 117 (checklist); Elgueta and Morrone, 1992: 135, 139 (types).

DIAGNOSIS: This species is recognized by the combination of the following characters: frons with depression; metepisternal suture present; elytra with small declivital tubercle on interval 3; sternites squamose; and female sternum 8 with long apodeme.

REDESCRIPTION: Body vestiture of thin, subcircular scales, and setae. Frons with depression. Eyes medium-sized (as long as rostrum height); supraocular sulcus present. Rostrum with three slender, dorsal keels. Scrobes subtriangular; suprascrobal keel fine. Antenna with scape gradually widening toward apex, exceeding hind margin of eye when resting in scrobe. Pronotum transverse; apical impression well developed; median carina, and subcircular lateral impressions absent; sulcus poorly developed; not tuberculate; postocular lobes slightly developed; densely squamose. Metepisternal suture present. Elytra with flat intervals; with small tubercles; base of interval 3 slightly prominent; humeri prominent; declivital tubercle on interval 3 small; setae multifid, strong, straight or

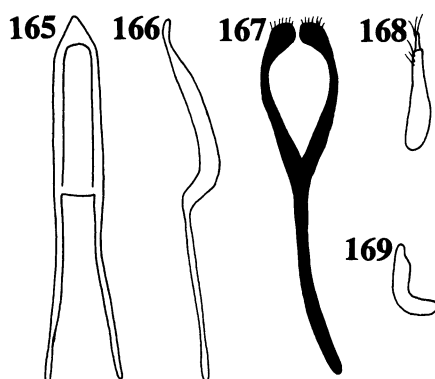

Figs. 165–169. *Puranius fasciculiger*, male and female genitalia. 165, Aedeagus, dorsal view; 166, aedeagus, lateral view; 167, female sternum 8; 168, hemisternites; 169, spermatheca.

slightly curved, blunt. *Sternites* lacking scales. *Legs* with all tibiae lacking mucro; with two spurs; squamose and with short setae. *Body length* 2.3–4.4 mm.

Male Genitalia: Aedeagus (figs. 165, 166) with produced apex; apical hairs absent; apodemes slightly longer than tube.

Female Genitalia: Sternum 8 (fig. 167) with long apodeme ($1.2 \times$ longer than plate); plate subelliptical, with open apex and short setae; arms long, reaching apex. Hemisternites (fig. 168) elongate, $5.0 \times$ longer than wide; lacking baculi; styli present. Spermatheca (fig. 169) with enlarged ramus; nodulus absent.

GEOGRAPHICAL DISTRIBUTION: Known from southern Chile (fig. 153), in the Valdivian entomofaunal region of O'Brien (1971).

TYPE MATERIAL: Lectotype male of *Listroderes frigidus* with the following labels: [323] [holotype ♂/ *frigidus*/ Germain] [*frigidus*/ P. G.] [*Puranius/ fasciculiger*/ (Blanchard)/ det. G. Kuschel/ 1981] [Lectotipo ♂/ *Listroderes frigidus*/ Elgueta & Morrone des. 1992] (MHNS). Fourteen paralectotypes with the same data (13 MHNS, 1 NZAC). Lectotype male of *Listroderes sobrinus* with the following labels: [326] [holotype ♂/ *sobrinus*/ Germain] [*sobrinus*/ P. G.] [*Puranius/ fasciculiger*/ (Blanchard)/ det. G. Kuschel/ 1981] [Lectotipo ♂/ *Listroderes sobrinus*/ Elgueta & Morrone des. 1992]. Three paralectotypes with the same data (MHNS).

OTHER MATERIAL EXAMINED: CHILE. CHILOE: Chepu, "on *Senecio smithii*," 23-

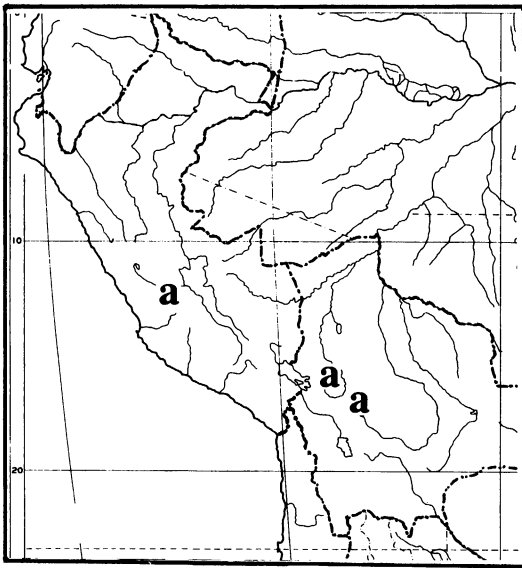

Fig. 170. Geographical distribution of the genus *Puranius*. a, *P. obrienorum*.

X-1958, G. Kuschel, 1 (NZAC); without precise data, 2 (MHNS). CONCEPCION: boca Bio-Bio, "at night," 24-VIII-1968, C. W. O'Brien, 3 (CWOB). LLANQUIHUE: Carlemapu, 21-II/3-III-1957, G. Kuschel, 2 (NZAC); Puerto Montt, 10-VII-1971, C. Stange, 1 (MHNS); Puerto Varas, 26-II-1945, E. A. Chapin, 1 (USNM). PALENA: Llanague, 22-VII-1965, 1 (MHNS). Without precise data: Santo Domingo, 24-X-1971, 1 (MHNS); 10 (5 MCZ, 2 MHNS, 2 NZAC, 1 USNM).

Puranius hispidus (Germain)

Figures 171-175

Listroderes hispidus Germain, 1896: 726, 1911: 205 (list); Kolbe, 1907: 104 (cat.); Schenkling and Marshall, 1931: 8 (cat.); Blackwelder, 1947: 813 (checklist).

Amathynetes hispidus; Kuschel, 1949: 45.

Puranius hispidus; Kuschel, 1955: 288.

Macrostyphlus hispidus; Kuschel, 1986: 117; Wibmer and O'Brien, 1986: 117 (checklist); Elgueta and Morrone, 1992: 136 (types).

DIAGNOSIS: This species is recognized by the combination of the following characters: frons with depression; pronotum with poorly developed, apical impression; elytra with base

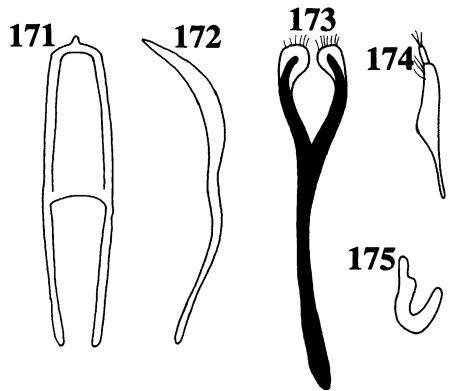

Figs. 171-175. *Puranius hispidus*, male and female genitalia. 171, Aedeagus, dorsal view; 172, aedeagus, lateral view; 173, female sternum 8; 174, hemisternites; 175, spermatheca.

of interval 3 tuberculate; and metatibiae with one spur.

REDESCRIPTION: Body vestiture of thin, subcircular scales, and setae. Frons with depression. Eyes medium-sized (as long as rostrum height); supraocular sulcus present. Rostrum with three slender, dorsal keels. Scrobes subtriangular; suprascrobal keel fine. Antenna with scape gradually widening toward apex, reaching hind margin of eye when resting in scrobe. *Pronotum* strongly transverse; apical impression poorly developed; median carina, and subcircular lateral impressions absent; sulcus poorly developed; not tuberculate; postocular lobes well developed; densely squamose. Metepisternal suture absent. *Elytra* with slightly convex intervals; with small tubercles; base of interval 3 tuberculate; humeri prominent; declivital tubercle on interval 3 absent; setae multifid, strong, straight or slightly curved, blunt. *Sternites* squamose. *Legs* with all tibiae lacking mucro; pro- and mesotibia with two spurs, metatibiae with one spur; squamose and with short setae. *Body length* 2.1-3.2 mm.

Male Genitalia: Aedeagus (figs. 171, 172) with produced apex; apical hairs absent; apodemes shorter than tube.

Female Genitalia: Sternum 8 (fig. 173) with very long apodeme (1.8× longer than plate); plate subcircular, with open apex and long setae; arms long, reaching apex. Hemisternites (fig. 174) elongate, 6.7× longer than

wide; with baculi; styli present. Spermatheca (fig. 175) with enlarged ramus; nodulus present.

GEOGRAPHICAL DISTRIBUTION: Known from central and southern Chile (fig. 164), in the Santiagan and Valdivian entomofaunal regions of O'Brien (1971).

TYPE MATERIAL: Lectotype male with the following labels: [116] [holotype ♂/ *hispidus*/ Germain] [*hispidus*/ P. G.] [*Puranius*/ *hispidus*/ (Germain)/ det. G. Kuschel/ 1981] [Lectotipo ♂/ *Listroderes hispidus*/ Elgueta & Morrone des. 1992] (MHNS). Seven paralectotypes with the same data (6 MHNS, 1 NZAC).

OTHER MATERIAL EXAMINED: CHILE. CA-CHAPOAL: W Embalse Barahona, 17-XII-1982, M. Elgueta, 1 (MHNS). QUILLOTA: M. N. La Campana, Ocoa, "Barber. No quemado. Tr:7," 25-V-1984, 2 (MHNS), "Barber. No quemado. Tr:14," 22-VI-1984, 1 (MHNS), "No quemado. Tr:16," 26-X-1984, C. Vivant, 1 (MHNS), "Quemado. Tr:27," 21-XII-1984, 1 (MHNS). VALDIVIA: Isla Teja, 15-XII-1970, F. Sáiz, 1 (CWOB).

Puranius inaequalis Germain

Figures 176–180

Puranius inaequalis Germain, 1896: 751, 1911: 205 (list); Schenkling and Marshall, 1931: 5 (cat.); Blackwelder, 1947: 812 (checklist); Kuschel, 1955: 288.

Amathynetes inaequalis; Kuschel, 1949: 45.

Macrostyphlus inaequalis; Kuschel, 1986: 117; Wibmer and O'Brien, 1986: 117 (checklist); Elgueta and Morrone, 1992: 136 (types).

DIAGNOSIS: This species is recognized by the hemisternites lacking styli.

REDESCRIPTION: Body vestiture of thick, subcircular scales, and setae. Frons lacking fovea. Eyes small (as long as half of rostrum height); supraocular sulcus present. Rostrum lacking dorsal keels. Scrobes linear; suprascrobial keel fine. Antenna with scape inflated, reaching hind margin of eye when resting in scrobe. *Pronotum* strongly transverse; apical impression poorly developed; median carina present; sulcus poorly developed; two subcircular, lateral impressions; not tuberculate; postocular lobes well developed; densely squamose. Metepisternal suture absent. *Elytra* with flat intervals; with small tubercles;

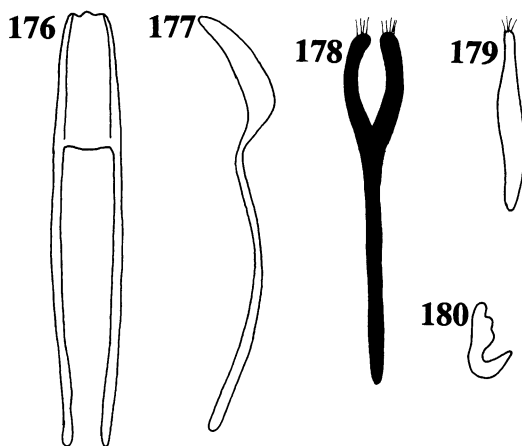

Figs. 176–180. *Puranius inaequalis*, male and female genitalia. 176, Aedeagus, dorsal view; 177, aedeagus, lateral view; 178, female sternum 8; 179, hemisternites; 180, spermatheca.

base of interval 3 tuberculate; humeri rounded; declivital tubercle on interval 3 absent; setae multifid, strong, straight or slightly curved, blunt. *Sternites* lacking scales. *Legs* with all tibiae lacking mucro; with two spurs; squamose and with long setae. *Body length* 2.6–4.0 mm.

Male Genitalia: Aedeagus (figs. 176, 177) with produced apex; apical hairs absent; apodemes more than twice length of tube.

Female Genitalia: Sternum 8 (fig. 178) with very long apodeme (1.9 × longer than plate); plate subelliptical, with open apex and long setae; arms long, reaching apex. Hemisternites (fig. 179) elongate, 8.2 × longer than wide; lacking baculi; styli absent. Spermatheca (fig. 180) with short ramus; nodulus present.

GEOGRAPHICAL DISTRIBUTION: Known from central Chile (fig. 191), in the Coquimban entomofaunal region of O'Brien (1971).

TYPE MATERIAL: Lectotype male with the following labels: [321] [Pemehue] [holotype ♂/ *Puranius*/ *inaequalis*/ Germain] [*inaequalis*/ P. G.] [*Puranius*/ *inaequalis*/ Germain/ det. G. Kuschel/ 1981] [Lectotipo ♂/ *Puranius inaequalis*/ Elgueta & Morrone des. 1992] (MHNS). Ten paralectotypes with the same data (MHNS).

OTHER MATERIAL EXAMINED: CHILE. PECTORCA: Huaquén, 22/24-IX-1961, L. E. Peña, 2 (HAHC). SANTIAGO: Est. Coba-

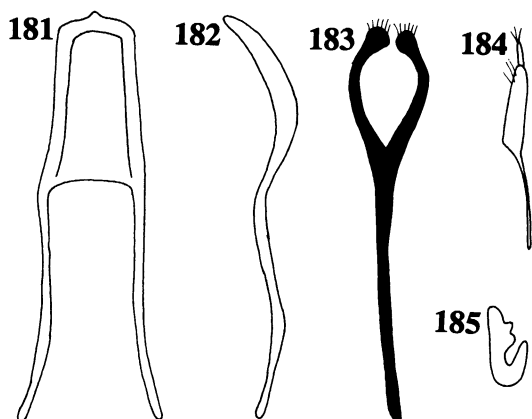

Figs. 181–185. *Puranius nigrinus*, male and female genitalia. 181, Aedeagus, dorsal view; 182, aedeagus, lateral view; 183, female sternum 8; 184, hemisternites; 185, spermatheca.

burrias, 21-VII-1975, L. E. Peña, 6 (HAHC); Quebrada Macul, 15-VIII-1947, L. E. Peña, 1 (NZAC). SAN FELIPE DE ACONCAGUA: El Cobre, Q. El Soldado, 8-VIII-1968, "berlese funnel," C. W. O'Brien, 13 (CWOB); Trampas, Quebrada Verde, Ptas. Negras, 12/19-XI-1972, M. Pino, 1 (MHNS)

***Puranius midas*, new species**

Figures 144, 145

DIAGNOSIS: This species is recognized by the combination of the following characters: pronotum lacking median sulcus; metepisternal suture present; and elytra with intervals slightly convex and small declivital tubercle on interval 3.

DESCRIPTION: Holotype male. Body vestiture of thin, subcircular scales, and setae. Frons with fovea. Eyes medium-sized (as long as rostrum height); supraocular sulcus present. Rostrum lacking dorsal keels. Scrobes subtriangular; suprascrobal keel fine. Antenna with scape gradually widening toward apex, exceeding hind margin of eye when resting in scrobe. *Pronotum* transverse; apical impression well developed; median carina, sulcus, and subcircular, lateral impressions absent; not tuberculate; postocular lobes well developed; densely squamose. Metepisternal suture absent. *Elytra* with slightly convex intervals; not tuberculate; base of interval 3

slightly prominent; humeri prominent; declivital tubercle on interval 3 small; setae multifid, slender, straight or slightly curved, blunt. *Sternites* squamose. *Legs* with all tibiae lacking mucro; pro- and mesotibia with one spur, metatibia lacking spurs; squamose and with short setae. *Body length* 3.8 mm.

Male Genitalia: Aedeagus (figs. 144, 145) with produced apex; apical hairs absent; apodemes slightly longer than tube.

Female: Unknown.

GEOGRAPHICAL DISTRIBUTION: Known from the type locality, Chile.

TYPE MATERIAL: Holotype male with the following labels: [Chili./ F. E. Delfin, 1903.] [*Puranius/ midas* Morrone/ holotype male] (AMNH).

ETYMOLOGY: The name of this species, a noun in apposition, is taken from the Greek *Midas*, for the mythological king at whose touch everything turned to gold, referring to the color of the scales of the body vestiture.

***Puranius nigrinus* (Fairmaire)**

Figures 181–185

Listroderes nigrinus Fairmaire, 1884: 503; Germain, 1896: 801; Schenkl and Marshall, 1931: 8 (cat.); Blackwelder, 1947: 813 (= *L. obscurus*)
Listroderes obscurus Germain, 1896: 832; Kolbe, 1907: 105 (cat.); Schenkl and Marshall, 1931: 9 (cat.); Blackwelder, 1947: 813 (checklist).
Listroderes obscurusnigrinus Germain, 1911: 205 (lapsus).

Amathynetes nigrinus; Kuschel, 1949: 45.

Amathynetes obscurus; Kuschel, 1949: 45 (= *A. nigrinus*).

Puranius nigrinus; Kuschel, 1955: 288.

Macrostyphlus nigrinus; Kuschel, 1986: 117; Wibmer and O'Brien, 1986: 117 (checklist); Elgueta and Morrone, 1992: 138 (types).

DIAGNOSIS: This species is recognized by the legs lacking scales, and the pronotum lacking apical impression.

REDESCRIPTION: Body vestiture of thin, subcircular scales, and setae. Frons with fovea. Eyes medium-sized (as long as rostrum height); supraocular sulcus present. Rostrum with three slender, dorsal keels. Scrobes subtriangular; suprascrobal keel fine. Antenna with scape gradually widening toward apex, reaching hind margin of eye when resting in

scrobe. *Pronotum* transverse; apical impression, median carina, sulcus, and subcircular, lateral impressions absent; not tuberculate; postocular lobes slightly developed; sparsely squamose. Metepisternal suture absent. *Elytra* with flat intervals; not tuberculate; base of interval 3 flat; humeri rounded; declivital tubercle on interval 3 absent; setae multifid, strong, straight or slightly curved, blunt. *Sternites* lacking scales. *Legs* with all tibiae lacking mucro; with two spurs; lacking scales and with short setae. *Body length* 3.8–4.8 mm.

Male Genitalia: Aedeagus (figs. 181, 182) with produced apex; apical hairs absent; apodemes slightly longer than tube.

Female Genitalia: Sternum 8 (fig. 183) with very long apodeme (1.8× longer than plate); plate sublupical, with open apex and short setae; arms long, reaching apex. Hemisternites (fig. 184) elongate, 9.0× longer than wide; with baculi; styli present. Spermatheca (fig. 185) with short ramus; nodulus present.

GEOGRAPHICAL DISTRIBUTION: Known from southern Chile and southern Argentina (fig. 164). Distribution in Chile lies in the southern Valdivian entomofaunal subregion of O'Brien (1971).

TYPE MATERIAL: Lectotype male of *Listroderes obscurus* with the following labels: [114] [Magl.] [holotype ♂/ *obscurus*/ Germain] [*obscurus*/ P. G.] [*Puranius nigrinus*/ (Fairm.)/ det. G. Kuschel/ 1981] [Lectotipo ♂/ *Listroderes obscurus*/ Elgueta & Morrone des. 1992]. Ten paralectotypes with the same data (MHNS).

OTHER MATERIAL EXAMINED: ARGENTINA. TIERRA DEL FUEGO: Bahía San Sebastián, Cerrillos, 21-IV-1971, O. S. Flint and G. F. Hevel, 1 (USNM); Bahía San Sebastián, Pta. de Arenas, 20-IV-1971, O. S. Flint and G. F. Hevel, 12 (USNM); Estancia Viamonte, W. Reynolds, 1 (BMNH); Ushuaia, 8/26-II-1961, B. Malkin, 12 (BPBM); Ushuaia, costa, "bajo piedras," 5-XI-1984, A. Sobral, 1 (CADIC), 7-VIII-1984, V. H. C., 1 (CADIC). CHILE. COYHAIQUE: 64 km SE Coyhaique, 20-I-1968, 1 (CWOB). LLANQUIHUE: Puerto Montt, 2-II-1971, M. Pino, 1 (MHNS). MAGALLANES: Cabo Negro, 14-II-1976, V. Pérez, 1 (MHNS), "alimentándose en flores de diente de león," 19-XI-1977, V. Pérez, 1 (MHNS); 20 km S Cam-

eron, 17-XI-1960, G. Kuschel, 1 (NZAC); Estancia Otway, 12-I-1966, Flint and Cekalovic, 1 (USNM); Lago Toro, La Península, 5-II-1951, T. Cekalovic, 5 (USNM); Los Robles, 13-II-1976, V. Pérez, 1 (MHNS); Estancia Fenton, 29-X-1960, G. Kuschel, 1 (NZAC); Laguna Escondida, 8-III-1969, T. Cekalovic, 8 (CMN); Monte Alto, 27-III-1959, T. Cekalovic, 1 (USNM), 7/11-III-1969, L. E. Peña, 2 (IPUM), 19-I-1974, C. Bordón, 1 (CBPC); camino Natales, III-1969, L. E. Peña, 1 (MHNS); 26 km W Punta Arenas, "under stones," 17-I-1968, L. and C. W. O'Brien, 9 (CWOB); río Verde (beach), "under wood," 16-I-1968, C. W. and L. O'Brien, 50 (CWOB); P. N. Torres del Paine, Río Grey, 18-II-1978, J. Petersen, 1 (IPUM), R. Trincado, 1 (IPUM); Pelecha, 20-XI-1986, M. Martinic, 1 (IPUM); Puerto Williams, XI-1955, O. Galindo, 3 (CNCI); Punta Arenas, Pape, 1 (DEI); [Punta Arenas], Instituto de la Patagonia, 7-X-1986, J. Petersen, 1 (IPUM); 56 km NW Punta Arenas, Cutter Cove, penguin colony and nests, 8-I-1985, S. and J. Peck, 9 (CMN); 6 km S Punta Arenas, "under stones," 16-I-1968, C. W. and L. O'Brien, 14 (CWOB); Río Pescado, 16-I-1968, L. and C. W. O'Brien, 1 (CWOB); Río Russfin, 30-X-1954, T. Cekalovic, 2 (CMN), 17/23-XI-1960, G. Kuschel, 1 (NZAC); Río Seco, 12-II-1976, T. Cekalovic, 1 (CMN); 35 km SE Río Verde, 16-I-1968, L. and C. W. O'Brien, 1 (CWOB); Seno Skyring, Río Pérez, 27-II-1972, F. Gómez, 1 (CMN); without precise data, Philippi, 1 (DEI), 1-II-1952, L. E. Peña, 1 (CWOB). ULTIMA ESPERANZA: Cerro Castillo, 10-II-1957, T. Cekalovic, 4 (USNM); Cerro Castillo, 10-II-1957, T. Cekalovic, 1 (MHNS), 9-I-1968, C. W. and L. O'Brien, 3 (CWOB), "under wood," 13-I-1968, C. W. and L. O'Brien, 34 (CWOB); Cerro Guido, 11-II-1957, T. Cekalovic, 1 (CMN); Cerro León, 19-I-1969, V. Pérez, 1 (MHNS); Dinamarquero, 20-XI-1986, M. Martinic, 1 (IPUM); Dos Lagunas, "under wood," 13-I-1968, C. W. and L. O'Brien, 48 (CWOB), 14-I-1968, C. W. and L. O'Brien, 6 (CWOB); Estancia Canelo, 17-I-1968, L. and C. W. O'Brien, 7 (CWOB); 26 km E Estancia Canelo, "on and under *Nothofagus*," 17-I-1968, 1 (CWOB); Dos Lagunas, 25-I-1952, T. Cekalovic, 1 (CMN); without pre-

cise data, 6-II-1951, T. Cekalovic, 1 (FIML). Without precise data: XII-1905, R. Thaxter, 2 (MCZ); Pape, 2 (DEI); 1 (USNM).

Puranius obrienorum, new species

Figures 133, 136, 139

DIAGNOSIS: This species is recognized by the tuberculate pronotum.

DESCRIPTION: Holotype female. Body vestiture of thick, subcircular scales, and setae. Frons lacking fovea. Eyes medium-sized (as long as rostrum height); supraocular sulcus absent. Rostrum lacking dorsal keels. Scrobes subtriangular; suprascrobal keel strongly developed. Antenna with scape gradually widening toward apex, reaching hind margin of eye when resting in scrobe. *Pronotum* transverse; apical impression well developed; median carina, and subcircular lateral impressions absent; sulcus poorly developed; tuberculate; postocular lobes slightly developed; sparsely squamose. Metepisternal suture absent. *Elytra* with slightly convex intervals; with small tubercles; base of interval 3 slightly prominent; humeri rounded; declivital tubercle on interval 3 absent; setae multifid, strong, straight or slightly curved, blunt. *Sternites* squamose. *Legs* with all tibiae lacking mucro; protibia with two spurs, meso- and metatibia with one spur; squamose and with short setae. *Body length* 3.1 mm.

Female Genitalia: Sternum 8 (fig. 133) with very long apodeme (2.5 × longer than plate); plate subrhomboidal, with sinuate apex and long setae; arms absent. Hemisternites (fig. 136) subtriangular, 1.3 × longer than wide; lacking baculi; styli present. Spermatheca (fig. 139) with short ramus; nodulus present.

Male: Unknown.

GEOGRAPHICAL DISTRIBUTION: Known from western Bolivia and southwestern Peru (fig. 170), in the Punan biogeographic province of Cabrera and Willink (1973).

TYPE MATERIAL: Holotype female with the following labels: [BOLIVIA, La Paz, La/ Cumbre, 12 mi NE/ La Paz, 4600 m. IV-7- / 1978 CW & L O'Brien] [*Puranius/ obrienorum* Morrone/ holotype female] (CWOB). Five paratypes with the same data (3 CWOB, 2 MLP). One paratype with the following labels: [BOLIVIA, Cbb., 55/ mi SW. Cocha-

bamba/ April 5, 1978/ C. W. & L. B. O'Brien] [*Puranius/ obrienorum* Morrone/ paratype] (CWOB). Four paratypes with the following labels: [BOLIVIA, La Paz, La/ Cumbre, 12 mi NE./ La Paz, 4600 m. IV-7- / 1978 G. B. Marshall] [*Puranius/ obrienorum* Morrone/ paratype] (2 AMNH, 2 CWOB). Three paratypes with the following labels: [BOLIVIA: La Paz/ La Cumbre, 25.xii.75/ 3800/4000 m., L. Peña] [H. & A. Howden/ Collection] [*Puranius/ obrienorum* Morrone/ paratype] (HAHC). Two paratypes with the following labels: [BOLIVIA, Cbb., 62/ mi SW. Cochabamba/ April 5, 1978/ G. B. Marshall] [*Puranius/ obrienorum* Morrone/ paratype] (CWOB). Two paratypes with the following labels: [BOLIVIA: Oruro- / Cochabamba/ Pongo, 4200 m./ 25.i.76, L. Peña] [H. & A. Howden/ Collection] [*Puranius/ obrienorum* Morrone/ paratype] (HAHC). One paratype with the following labels: [BOLIVIA: Oruro- / Cochabamba/ Lequepalca/ 24.i.76/ 3800 m./ Luis Peña] [H. & A. Howden/ Collection] [*Puranius/ obrienorum* Morrone/ paratype] (HAHC). One paratype with the following labels: [BOLIVIA, L. P., 13 mi/ NW. Alta La Paz, under/ stones Apr. 9. 1978/ C. W. & L. B. O'Brien] [*Puranius/ obrienorum* Morrone/ paratype] (CWOB). One paratype with the following labels: [BOLIVIA, Cbb./ 3 mi W. Challa/ April 5, 1978 CW&L/ O'Brien & Marshall] [*Puranius/ obrienorum* Morrone/ paratype] (CWOB). One paratype with the following labels: [BOLIVIA, Cbb./ 18 mi W. Challa/ April 5, 1978 C&L/ O'Brien & Marshall] [*Puranius/ obrienorum* Morrone/ paratype] (CWOB). One paratype with the following labels: [PERU, 3500 m./ Tarma-Jauja/ Road J. Mateu/ 21 March 1977] [*Puranius/ obrienorum* Morrone/ paratype] (CWOB).

ETYMOLOGY: I name this species after the specialists Charles and Lois O'Brien, whose generous advice and hospitality I greatly appreciate.

Puranius pusillus, new species

Figures 186–190

DIAGNOSIS: This species is recognized by the combination of the following characters: subcircular scales thick; frons with depression; and scape reaching hind margin of eye when resting in scrobe.

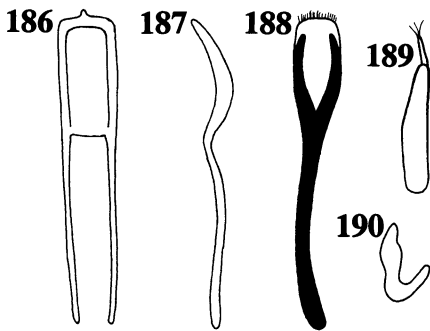

Figs. 186–190. *Puranius pusillus*, male and female genitalia. 186, Aedeagus, dorsal view; 187, aedeagus, lateral view; 188, female sternum 8; 189, hemisternites; 190, spermatheca.

DESCRIPTION: Holotype male. Body vestiture of thick, subcircular scales, and setae. Frons with depression. Eyes medium-sized (as long as rostrum height); supraocular sulcus present. Rostrum lacking dorsal keels. Scrobes subtriangular; suprascrobal keel fine. Antenna with scape gradually widening toward apex, reaching hind margin of eye when resting in scrobe. *Pronotum* transverse; apical impression well developed; median carina, and subcircular lateral impressions absent; sulcus poorly developed; not tuberculate; postocular lobes well developed; densely squamose. Metepisternal suture absent. *Elytra* with flat intervals; not tuberculate; base of interval 3 slightly prominent; humeri prominent; declivital tubercle on interval 3 absent; setae multifid, strong, straight or slightly curved, blunt. *Sternites* squamose. *Legs* with all tibiae lacking mucro; pro- and mesotibia with one spur, metatibia lacking spurs; squamose and with short setae. *Body* length 1.9 mm.

Male Genitalia: Aedeagus (figs. 186, 187) with produced apex; apical hairs absent; apodemes slightly longer than tube.

Female Genitalia: Sternum 8 (fig. 188) with very long apodeme ($1.8 \times$ longer than plate); plate subelliptical, with entire apex and short setae; arms long, reaching apex. Hemisternites (fig. 189) elongate, $5.0 \times$ longer than wide; lacking baculi; styli present. Spermatheca (fig. 190) with enlarged ramus; nodulus absent.

GEOGRAPHICAL DISTRIBUTION: Known only

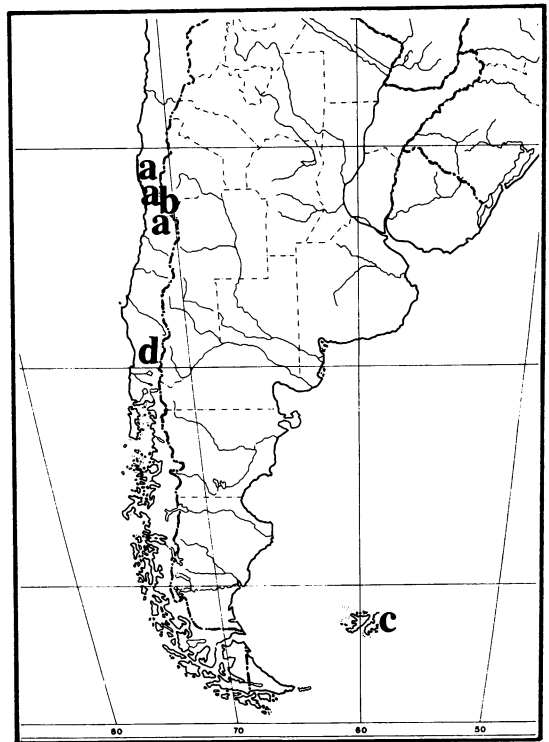

Fig. 191. Geographical distribution of the genus *Puranius*. a, *P. inaequalis*; b, *P. pusillus*; c, *P. scaber*; d, *P. tothus*.

from the type locality in central Chile (fig. 191), in the Coquimban entomofaunal region of O'Brien (1971).

TYPE MATERIAL: Holotype male with the following labels: [P. N, La Campana. Ocoa/Barber.-Quemado Tr:23-31-VIII-84, C. Viván T.] [*Puranius pusillus* Morrone/ holotype male] (MHNS). One paratype with the same data (MHNS). One paratype with the same data except Tr:14 and 22-VI-84 (MHNS). One paratype with the same data except Tr:15 and 25-V-84 (MLP).

ETYMOLOGY: From the Latin *pusillus* for very small, in reference to its body length.

Puranius scaber (Enderlein)

Figures 192–196

Listroderes scaber Enderlein, 1907: 63; Kolbe, 1907: 105 (cat.).

Reichertia scabra; Enderlein, 1912: 33; Champion, 1918: 183; Schenking and Marshall, 1931: 13 (cat.); Blackwelder, 1947: 814 (checklist); Voisin, 1987: 94 (biogeogr.).

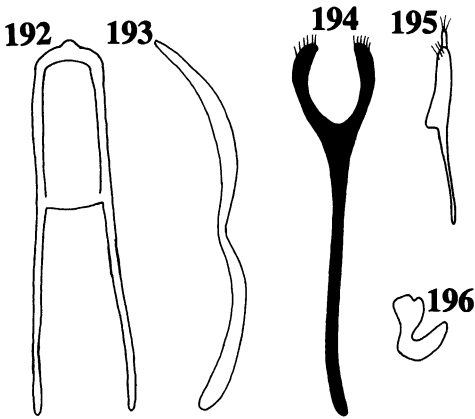

Figs. 192–196. *Puranius scaber*, male and female genitalia. 192, Aedeagus, dorsal view; 193, aedeagus, lateral view; 194, female sternum 8; 195, hemisternites; 196, spermatheca.

Amathynetes scaber; Kuschel, 1949: 45, 1952: 137; Ringuelet, 1955: 434 (biogeogr.); Schweiger, 1958: 42 (biogeogr.); Robinson, 1984: 7 (list).
Puranius scaber; Kuschel, 1955: 288.
Macrostyphlus scaber; Kuschel, 1986: 117; Wibmer and O'Brien, 1986: 117 (checklist).

DIAGNOSIS: This species is recognized by the elytra with strongly convex intervals.

REDESCRIPTION: Body vestiture of thin, subcircular scales, and setae. Frons with fovea. Eyes medium-sized (as long as rostrum height); supraocular sulcus absent. Rostrum with three strong, dorsal keels. Scrobes subtriangular; suprascrobal keel fine. Antenna with scape gradually widening toward apex, reaching hind margin of eye when resting in scrobe. *Pronotum* transverse; apical impression well developed; median carina, sulcus, and subcircular, lateral impressions absent; not tuberculate; postocular lobes well developed; sparsely squamose. Metepisternal suture present. *Elytra* with strongly convex intervals; not tuberculate; base of interval 3 tuberculate; humeri prominent; declivital tubercle on interval 3 absent; setae multifid, strong, straight or slightly curved, blunt. *Sternites* lacking scales. *Legs* with all tibiae lacking mucro; with one spur; squamose and with short setae. *Body length* 4.0–5.0 mm.

Male Genitalia: Aedeagus (figs. 192, 193) with produced apex; apical hairs absent; apodemes slightly longer than tube.

Female Genitalia: Sternum 8 (fig. 194) with very long apodeme (2.6x longer than plate); plate subcircular, with open apex and short setae; arms long, reaching apex. Hemisternites (fig. 195) elongate, 8.5x longer than wide; with baculi; styli present. Spermatheca (fig. 196) with short ramus; nodulus present.

GEOGRAPHICAL DISTRIBUTION: Known from the Falkland Islands (fig. 191), in the Insular province (Subantarctic dominion) of Cabrera and Willink (1973).

MATERIAL EXAMINED: ARGENTINA. FALKLAND ISLANDS: East Falkland, Fitzroy settlement by Antioja river, near Peak Stranty, XI-1989, A. Macfadyen, 1 (AMPC); Port Stanley, "common," XI-1964, D. Davidson, 3 (CWOB); West Falkland, Skottsberg, 1 (NZAC); West Falkland, 1 (NZAC); without precise data, 1 (CWOB), C. C. Pool, 31-1908, 2 (BMNH).

Puranius sylvanius, new species

Figures 197–201

DIAGNOSIS: This species is recognized by the combination of the following characters: scrobes linear; elytra with small declivital tubercle on interval 3, and setae slender, curved, tapered; and tibial setae long.

DESCRIPTION: Holotype male. Body vestiture of thick, subcircular scales, and setae. Frons with fovea. Eyes medium-sized (as long as rostrum height); supraocular sulcus present. Rostrum lacking dorsal keels. Scrobes linear; suprascrobal keel fine. Antenna with scape gradually widening toward apex, reaching hind margin of eye when resting in scrobe. *Pronotum* strongly transverse; apical impression well developed; median carina, sulcus, and subcircular, lateral impressions absent; not tuberculate; postocular lobes slightly developed; densely squamose. Metepisternal suture absent. *Elytra* with slightly convex intervals; with small tubercles; base of interval 3 slightly prominent; humeri rounded; declivital tubercle on interval 3 small; setae simple, slender, curved, tapered. *Sternites* squamose. *Legs* with all tibiae lacking mucro; with two spurs; squamose and with long setae. *Body length* 2.3 mm.

Male Genitalia: Aedeagus (figs. 197, 198) with produced apex; apical hairs absent; apodemes more than twice length of tube.

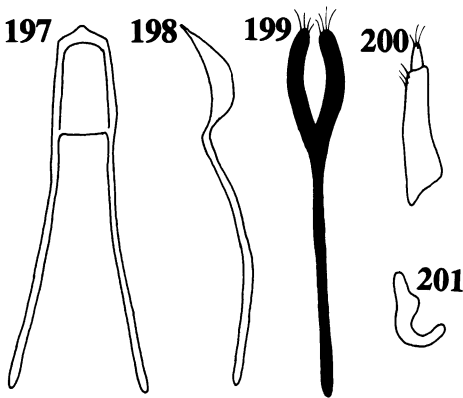

Figs. 197–201. *Puranius sylvanius*, male and female genitalia. 197, Aedeagus, dorsal view; 198, aedeagus, lateral view; 199, female sternum 8; 200, hemisternites; 201, spermatheca.

Female Genitalia: Sternum 8 (fig. 199) with very long apodeme ($2.0\times$ longer than plate); plate subelliptical, with open apex and long setae; arms long, reaching apex. Hemisternites (fig. 200) elongate, $4.0\times$ longer than wide; lacking baculi; styli present. Spermatheca (fig. 201) with enlarged ramus; nodulus present.

GEOGRAPHICAL DISTRIBUTION: Only from the type locality in central Chile (fig. 202), in the Coquimban entomofaunal region of O'Brien (1971).

TYPE MATERIAL: Holotype male with the following labels: [CHILE, Coquimbo: Fray/Jorge National Park, / 580 m., Nov.3, 1981/ N. Platnick & R. Schuh] [Valdivian forest relict, / concentrated berlese/ floor litter & root mat] [*Puranius/ sylvanius* Morrone/ holotype male] (AMNH). Thirty paratypes with the same data (18 AMNH, 4 BMNH, 4 CMNH, 4 MLP).

ETYMOLOGY: From the Latin *sylva* for forest, referring to the place where the type specimens were collected.

***Puranius torosus*, new species**

Figures 203–207

DIAGNOSIS: This species is recognized by the elytra with large, conspicuous tubercles, and the metatibiae mucronate.

DESCRIPTION: Holotype male. Body vestiture of thin, subcircular scales, and setae. Frons with depression. Eyes medium-sized (as long as rostrum height); supraocular sul-

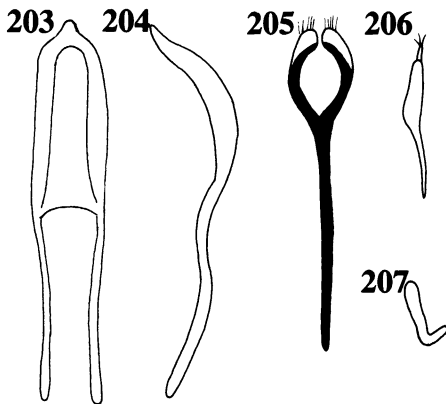

Fig. 202. Geographical distribution of the genus *Puranius*. a, *P. sylvanius*; b, *P. torosus*; c, *P. tuberosus*; d, *P. verrucosus*; e, *P. vulgaris*.

cus present. Rostrum with three slender, dorsal keels. Scrobes linear; suprascrobal keel fine. Antenna with scape inflated, exceeding hind margin of eye when resting in scrobe. *Pronotum* transverse; apical impression well developed; median carina, and subcircular lateral impressions absent; sulcus poorly developed; not tuberculate; postocular lobes slightly developed; densely squamose. Metepisternal suture absent. *Elytra* with flat intervals; with large, conspicuous tubercles; base of interval 3 slightly prominent; humeri tuberculate; declivital tubercle on interval 3 small; setae multifid, strong, straight or slightly curved, blunt. *Sternites* squamose. *Legs* with pro- and mesotibia lacking mucro, metatibia mucronate; all tibiae with two spurs; squamose and with short setae. *Body length* 2.9 mm.

Male Genitalia: Aedeagus (figs. 203, 204) with produced apex; apical hairs absent; apodemes shorter slightly longer tube.

Female Genitalia: Sternum 8 (fig. 205) with



Figs. 203–207. *Puranius torosus*, male and female genitalia. **203**, Aedeagus, dorsal view; **204**, aedeagus, lateral view; **205**, female sternum 8; **206**, hemisternites; **207**, spermatheca.

very long apodeme ($2.6 \times$ longer than plate); plate subcircular, with open apex and long setae; arms long, reaching apex. Hemisternites (fig. 206) elongate, $8.7 \times$ longer than wide; with baculi; styli present. Spermatheca (fig. 207) with enlarged ramus; nodulus absent.

GEOGRAPHICAL DISTRIBUTION: Known from central Chile (fig. 202), in the Coquimban entomofaunal region of O'Brien (1971).

TYPE MATERIAL: Holotype male with the following labels: [Los Vilos/ I. 1975/ Jackson] [29] [*Puranius*/ sp.] [*Puranius*/ sp./ det. M. Elgueta 1981] [*Puranius*/ *torosus* Morrone/ holotype male] (MHNS). Eight paratypes with the same data (6 MHNS, 2 MLP). One paratype with the following labels: [Q-10-2/ sp. 2] [Rodelillo/ 18 Abril 83/ MATORRAL/ QUEMADO] [*Puranius*/ *torosus* Morrone/ paratype] (MHNS).

ETYMOLOGY: From the Latin *torus* for round elevation, referring to the tubercles of the elytral surface.

***Puranius tothus*, new species**

Figures 208–212

DIAGNOSIS: This species is recognized by the apical dentiform projection of the elytra. In addition, the combination of scape inflated and reaching hind margin of eye when resting on scrobe; and elytral setae simple, is diagnostic.

DESCRIPTION: Holotype male. Body vestiture of thin, subcircular scales, and setae. Frons with fovea. Eyes medium-sized (as long as rostrum height); supraocular sulcus present. Rostrum with three slender, dorsal keels. Scrobes linear; suprascrobal keel fine. Antenna with scape inflated, exceeding hind margin of eye when resting in scrobe. *Pro-notum* transverse; apical impression well developed; median carina, sulcus, and subcircular, lateral impressions absent; not tuberculate; postocular lobes well developed; sparsely squamose. Metepisternal suture present. *Elytra* with flat intervals; with small tubercles; base of interval 3 slightly prominent; humeri prominent; declivital tubercle on interval 3 absent; with apical dentiform projection; setae simple, strong, straight or slightly curved, blunt. *Sternites* lacking scales. *Legs* with all tibiae lacking mucro; with two spurs; squamose and with short setae. *Body length* 3.5 mm.

Male Genitalia: Aedeagus (figs. 208, 209) with produced apex; apical hairs absent; apodemes slightly longer than tube.

Female Genitalia: Sternum 8 (fig. 210) with very long apodeme ($2.5 \times$ longer than plate); plate subelliptical, with open apex and short setae; arms long, reaching apex. Hemisternites (fig. 211) elongate, $6.6 \times$ longer than wide; with baculi; styli present. Spermatheca (fig. 212) with enlarged ramus; nodulus present.

GEOGRAPHICAL DISTRIBUTION: Known only from the type locality in southern Chile (fig. 191), in the Valdivian entomofaunal region of O'Brien (1971).

TYPE MATERIAL: Holotype male with the following labels: [Prov. Valdivia/ Vald., CHILE/ 20.4.85/ E. Krahmer] [*Puranius*/ *tothus* Morrone/ holotype male] (MHNS). One paratype with the same data except 22.4.85 (MHNS).

ETYMOLOGY: From the Anglo-Saxon *toth* for teeth, referring to the dentiform projection of the elytra.

***Puranius tuberosus* Germain**

Figures 146, 147

Puranius tuberosus Germain, 1896, 1911: 205 (list); Schenklung and Marshall, 1931: 5 (cat.); Kuschel, 1955: 288; Blackwelder, 1947: 812 (check-list).

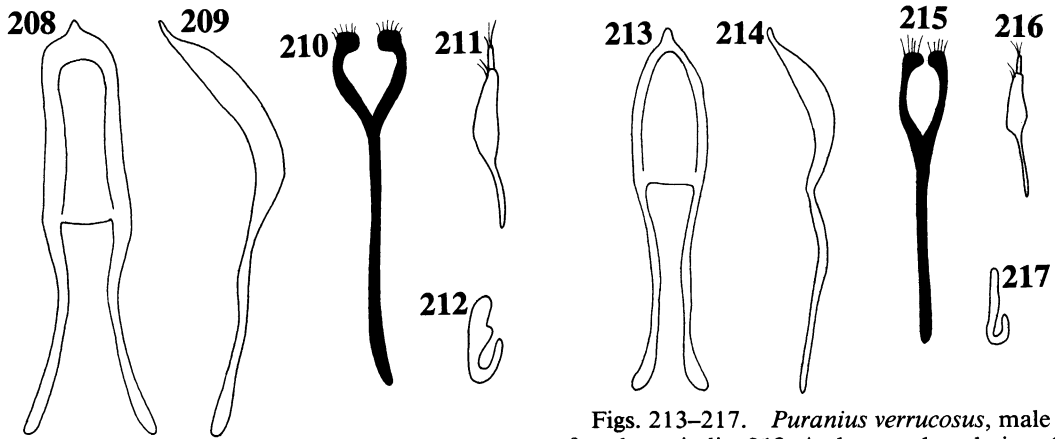

Figs. 208–212. *Puranius tothus*, male and female genitalia. 208, Aedeagus, dorsal view; 209, aedeagus, lateral view; 210, female sternum 8; 211, hemisternites; 212, spermatheca.

Amathynetes tuberosus; Kuschel, 1949: 45.
Macrostiphylus tuberosus; Kuschel, 1986: 118;
 Wibmer and O'Brien, 1986: 118 (checklist); Elgueta and Morrone, 1992: 139 (types).

DIAGNOSIS: This species is recognized by the combination of the following characters: frons lacking fovea; eyes small (as long as half of rostrum height); scape gradually widening toward apex; elytra with small tubercles; sternites lacking scales; spermatheca with short ramus; hemisternites short; and tibial setae long.

REDESCRIPTION: Body vestiture of thick, subcircular scales, and setae. Frons lacking fovea. Eyes small (as long as half of rostrum height); supraocular sulcus present. Rostrum lacking dorsal keels. Scrobes subtriangular; suprascrobal keel fine. Antenna with scape gradually widening toward apex, reaching hind margin of eye when resting in scrobe. Pronotum strongly transverse; apical impression poorly developed; median carina, sulcus, and subcircular, lateral impressions absent; not tuberculate; postocular lobes slightly developed; densely squamose. Metepisternal suture absent. Elytra with flat intervals; with small tubercles; base of interval 3 slightly prominent; humeri rounded; declivital tubercle on interval 3 absent; setae multifid, strong, straight or slightly curved, blunt. Sternites lacking scales. Legs with all tibiae lack-

Figs. 213–217. *Puranius verrucosus*, male and female genitalia. 213, Aedeagus, dorsal view; 214, aedeagus, lateral view; 215, female sternum 8; 216, hemisternites; 217, spermatheca.

ing mucro; with two spurs; squamose and with short setae. Body length 2.8–3.1 mm.

Male Genitalia: Aedeagus (figs. 146, 147) with produced apex; apical hairs absent; apodemes more than twice length of tube.

Female: Unknown.

GEOGRAPHICAL DISTRIBUTION: Known from central Chile (fig. 202), in the Coquimban entomofaunal region of O'Brien (1971).

TYPE MATERIAL: Lectotype male with the following labels: [Coqbo] [117] [holotype ♂/ *Puranius/ tuberosus/* Germain] [*tuberosus/ P. G.*] [*Puranius/ tuberosus/* Germain/ det. G. Kuschel/ 1981] [Lectotipo ♂/ *Puranius tuberosus/* Elgueta & Morrone des. 1992] (MHNS). Two paralectotypes with the same data (1 MHNS, 1 NZAC).

OTHER MATERIAL EXAMINED: CHILE. CHOAPA: 10 km S. Zapallar, "berlese funnel," C. W. O'Brien, 1 (CWOB).

Puranius verrucosus (Germain)

Figures 213–217

Listroderes verrucosus Germain, 1896: 728, 1911: 205 (list); Kolbe, 1907: 104 (cat.); Schenklind and Marshall, 1931: 10 (cat.); Blackwelder, 1947: 813 (checklist).

Amathynetes verrucosus; Kuschel, 1949: 45.

Puranius verrucosus; Kuschel, 1955: 288.

Macrostiphylus verrucosus; Kuschel, 1986: 118; Wibmer and O'Brien, 1986: 118 (checklist); Elgueta and Morrone, 1992: 140 (types).

DIAGNOSIS: This species is recognized by the pronotum with deep median sulcus.

REDESCRIPTION: Body vestiture of thick, subcircular scales, and setae. Frons with fovea. Eyes medium-sized (as long as rostrum height); supraocular sulcus present. Rostrum with three slender, dorsal keels. Scrobes subtriangular; suprascrobal keel fine. Antenna with scape inflated, exceeding hind margin of eye when resting in scrobe. *Pronotum* transverse; apical impression well developed; median carina, and subcircular lateral impressions absent; sulcus deep; not tuberculate; postocular lobes well developed; densely squamose. Metepisternal suture absent. *Elytra* with flat intervals; with large, conspicuous tubercles; base of interval 3 slightly prominent; humeri tuberculate; declivital tubercle on interval 3 large; setae multifid, strong, straight or slightly curved, blunt. *Sternites* squamose. *Legs* with all tibiae lacking mucro; pro- and mesotibia with two spurs, metatibia with one spur; squamose and with short setae. *Body length* 2.2–3.7 mm.

Male Genitalia: Aedeagus (figs. 213, 214) with produced apex; apical hairs absent; apodemes slightly longer than tube.

Female Genitalia: Sternum 8 (fig. 215) with very long apodeme (1.8 × longer than plate); plate subelliptical, with open apex and long setae; arms long, reaching apex. Hemisternites (fig. 216) elongate, 6.5 × longer than wide; with baculi; styli present. Spermatheca (fig. 217) with enlarged ramus; nodulus absent.

GEOGRAPHICAL DISTRIBUTION: Known from central Chile (fig. 202), in the Coquimban and Santiagan entomofaunal regions of O'Brien (1971).

TYPE MATERIAL: Lectotype male with the following labels: [324] [holotype ♂/ *verrucosus*/ Germain] [*verrucosus*/ P. G.] [*Puranius verrucosus*/ (Germain)/ det. G. Kuschel/ 1981] [Lectotipo ♂/ *Listroderes verrucosus*/ Elgueta & Morrone des. 1992] (MHNS). Eight paralectotypes with the same data (6 MHNS, 2 NZAC).

OTHER MATERIAL EXAMINED: CHILE. CHOAPA: km 272 Panamericana Norte, 18-VII-1985, M. Elgueta, 6 (MHNS); Los Vilos, "under stones," 13-XII-1967, C. W. and L. O'Brien, 1 (CWOB). CONCEPCION: without precise data, VII-1903, M. Herbst, 1 (MHNS). MELIPILLA: Curacaví, 12-X-1967, C. W. O'Brien, 1 (CWOB). PETORCA:

Huaquén, 22/24-XI-1961, L. E. Peña, 25 (HAHC) Santiago: El Manzano, 30-XI-1968, D. Correa, 1 (CWOB); 3 km E El Manzano, 8-XII-1968, D. Correa, 1 (CWOB); 2 km W El Manzano, 8-XII-1968, D. Correa coll, 1 (CWOB); 15 km W Padre Hurtado, 12-X-1967, J. Apablaza and C. W. O'Brien, 27 (CWOB); Pudahuel, III-1953, L. E. Peña, 10 (MHNS); 20 km W Rungue, "under stones," 19-XI-1967, J. Apablaza and C. W. O'Brien, 3 (CWOB). VALPARAISO: 14 km E Puchuncaví, 1500 ft, 4-X-1967, L. and C. W. O'Brien, 1 (CWOB), "at night," L. and C. W. O'Brien, 1 (CWOB); Quillota, 1 (NZAC); Quintero, "en heces de vacuno," 19-VI-1967, J. Solervicens, 1 (CWOB); San Jerónimo, Casa Blanca, 8-IV-1971, J. Solervicens, 1 (MHNS). Without precise data: 10 (MHNS).

Puranius vulgaris, new species

Figures 134, 137, 140

DIAGNOSIS: This species is recognized by the combination of the following characters: scape inflated, reaching hind margin of eyes when resting in scrobe; elytra with small tubercles; and hemisternites with baculi.

DESCRIPTION: Holotype female. Body vestiture of thin, subcircular scales, and setae. Frons with fovea. Eyes small (as long as half of rostrum height); supraocular sulcus present. Rostrum with three slender, dorsal keels. Scrobes subtriangular; suprascrobal keel fine. Antenna with scape inflated, reaching hind margin of eye when resting in scrobe. *Pronotum* transverse; apical impression well developed; median carina, and subcircular lateral impressions absent; sulcus poorly developed; not tuberculate; postocular lobes slightly developed; densely squamose. Metepisternal suture absent. *Elytra* with flat intervals; with small tubercles; base of interval 3 slightly prominent; humeri prominent; declivital tubercle on interval 3 absent; setae multifid, strong, straight or slightly curved, blunt. *Sternites* squamose. *Legs* with all tibiae lacking mucro; with one spur; squamose and with short setae. *Body length* 2.5 mm.

Female Genitalia: Sternum 8 (fig. 134) with very long apodeme (2.1 × longer than plate); plate subelliptical, with sinuate apex and long setae; arms long, reaching apex. Hemisternites (fig. 137) elongate, 6.6 × longer than

wide; with baculi; styli present. Spermatheca (fig. 140) with enlarged ramus; nodulus absent.

Male: Unknown.

GEOGRAPHICAL DISTRIBUTION: Known from southern Argentina and southern Chile (fig. 202). Distribution in Chile lies in the Santiagan entomofaunal region of O'Brien (1971).

TYPE MATERIAL: Holotype female with the following labels: [ARGENTINA/ Lago Puelo/ Chubut/ I-13-1963/ A. Kovacs] [*Puranus vulgaris* Morrone/ holotype female] (AMNH). Thirty paratypes with the same data

(17 AMNH, 2 BMNH, 3 CMNH, 4 MHNS, 4 MLP).

OTHER MATERIAL EXAMINED: ARGENTINA. RIO NEGRO: El Bolsón, 20-XII-1965, A. Kovacs, 3 (AMNH). CHILE. SANTIAGO: Alto Cantillana, "Berlese," "*Ephedra*," 28/29-V-1981, M. Elgueta, 1 (MHNS), "Berlese," "bajo *Nastanthus*," 1 (MHNS), 2/5-XI-1981, "Berlese," "bajo coirón 2250 m," 1 (MHNS), 31-X-1982, "*Baccharis*," 1 (MHNS).

ETYMOLOGY: From the Latin *vulgaris* for common or ordinary.

REFERENCES

- Blackwelder, R. E.
1947. Checklist of the Coleopterous insects of Mexico, Central America, the West Indies, and South America. Part 5. Bull. U.S. Natl. Mus. (185): i-iv, 765-925.
- Blanchard, C. E.
1851. Fauna Chilena, Insectos. Coleópteros. In C. Gay, Historia física y política de Chile, Zoología 5: 286-429.
- Brooks, D. R.
1985. Historical ecology: A new approach to studying the evolution of ecological associations. Ann. Missouri Bot. Gard. 72: 660-680.
1990. Parsimony analysis in historical biogeography and coevolution: Methodological and theoretical update. Syst. Zool. 39(1): 14-30.
- Cabrera, A. L., and A. Willink
1973. Biogeografía de América Latina. Monografía 13, Serie de Biología, OEA, Washington D.C.
- Champion, G. C.
1918. Notes on various South American Coleoptera collected by Charles Darwin during the voyage of the "Beagle", with descriptions of new genera and species. Entomol. Mon. Mag. 54: 43-55.
- Cockerell, T. D. A.
1906. Preoccupied generic names of Coleoptera. Entomol. News 17(7): 240-244.
- Croizat, L.
1958. Panbiogeography. Vol. 1a, 1b. Published by the author, Caracas.
1964. Space, time, form: the biological synthesis. Published by the author, Caracas.
- Elgueta, M.
1988. Insectos epigeos de ambientes altomontanos en Chile Central: Algunas consideraciones biogeográficas con especial referencia a Tenebrionidae y Curculionidae (Coleoptera). Bol. Mus. Nac. Hist. Nat. Chile 41: 125-144.
- Elgueta, M., and J. J. Morrone
1992. Los ejemplares tipo de "Listroderitos" (Coleoptera: Curculionidae) de Germain (1895-1896), de la colección del Museo Nacional de Historia Natural (Santiago, Chile). Bol. Mus. Nac. Hist. Nat. Chile 43: 131-142.
- Enderlein, G.
1907. Die Rüsselkäfer der Falkland=Inseln. 13. Beitrag zur Kenntnis der antarktischen Fauna. Stett. Entomol. Z. 68: 36-69.
1912. Die Insekten des Antarkto-Archiplatea-Gebietes (Feuerland, Falklands-Inseln, Süd-Georgien). 20. Beitrag zur Kenntnis der antarktischen Fauna. K. Sven. Vetensk. Akad. Handl. 48(3): 1-170.
- Fairmaire, L.
1884. Note sur quelques Coléoptères de Magellan et de Santa-Cruz. Ann. Soc. Entomol. France 1883(1884), ser. 6, 3: 483-506.
- Farris, J. S.
1988. Hennig86 reference. Version 1.5. Published by the author.
- Forey, P. L., C. J. Humphries, I. J. Kitching, R. W. Scotland, D. J. Siebert, and D. M. Williams
1992. Cladistics: A practical course in systematics. The Systematics Association Publication no. 10. Oxford: Clarendon Press.
- Germain, P.
1896. Apuntes sobre los insectos de Chile. Estudio i descripción de los Listroderitos

- de Chile i tierras magallánicas de la colección del Museo Nacional i la de Don Fernando Paulsen. An. Univ. Chile 93: 791–838, 94: 721–752.
1911. Informes de los jefes de Sección i otros empleados del Museo. I-Informe del jefe de la Sección de Entomología. Bol. Mus. Nac. Chile 3(1): 197–221.
- Humphries, C. J., and L. R. Parenti
1986. Cladistic biogeography. Oxford: Clarendon Press.
- Hustache, A.
1930. Deux Curculionides nouveaux du Chili. Rev. Chilena Hist. Nat. 34: 266–271.
1938a. Curculionides nouveaux de l'Amérique méridionale, qui se trouvent dans le Deutsches Entomologisches Institut. (1ère note). Arb. Morphol. Taxon. Entomol. Berlin-Dahlem 5(2): 174–184.
1938b. Curculionides nouveaux de l'Amérique méridionale, qui se trouvent dans le Deutsches Entomologisches Institut. 2ième note. Arb. Morphol. Taxon. Entomol. Berlin-Dahlem 5(3): 265–288.
- Kirsch, T. [F. W.]
1889. Coleopteren gesammelt in den Jahren 1868–1877 auf einer Reise durch Süd Amerika von Alphons Stübel. Abh. Ber. Zool. Mus. Dresden, 1888/89 (1889), (4): 1–58.
- Kolbe, H. [J.]
1907. Coleopteren. In Ergebnisse der Hamburger Magalhaensische Sammelreise 8(4): 1–125.
- Kuschel, G.
1949. Los "Curculionidae" del extremo norte de Chile (Coleoptera, Curcul. ap. 6). Acta Zool. Lilloana 8: 5–54.
1952. Cylydrorhininae aus dem Britischen Museum. (Col. Curculionidae, 8. Beitr.). Ann. Mag. Nat. Hist., ser. 12, 5: 121–137.
1955. Nuevas sinonimias y anotaciones sobre Curculionoidea (1) (Coleoptera). Rev. Chilena Entomol. 4: 261–312.
1986. In G. J. Wibmer and C. W. O'Brien, Annotated checklist of the weevils (Curculionidae sensu lato) of South America (Coleoptera: Curculionoidea). Mem. Am. Entomol. Inst. 39: xvi + 563 pp.
1990. Beetles in a suburban environment: A New Zealand case study. The identity and status of Coleoptera in the natural and modified habitats of Lynfield, Auckland (1974–1989). DSIR Dep. Sci. Ind. Res. Plant Prot. Rep. 3: 1–118.
- Morrone, J. J.
1990. *Philippius* Germain, a remarkable Listroderini from southern South America. Coleopt. Bull. 44(4): 429–436.
- 1992a. Revisión sistemática, análisis cladístico y bio geografía histórica de los géneros *Falklandius* Enderlein y *Lanteriella* gen. nov. (Coleoptera: Curculionidae). Acta Entomol. Chilena 17: 157–174.
1992b. Revisión sistemática y análisis cladístico del género *Antarctobius* Fairmaire (Coleoptera: Curculionidae). Neotropica 38(99): 3–20.
1992c. Revision of *Trachodema* Blanchard with the description of an allied genus from central Chile (Insecta, Coleoptera, Curculionidae). Zool. Scr. 21(4): 417–422.
1993a. Revisión sistemática de un nuevo género de Rhytirrhini (Coleoptera: Curculionidae), con un análisis biogeográfico del dominio subantártico. Bol. Soc. Biol. Concepción 64: 129–145.
1993b. Systematic revision of the *costirostris* species group of the genus *Listroderes* Schoenherr (Coleoptera: Curculionidae). Trans. Am. Entomol. Soc. 119(4): 271–315.
1993c. Revisión de las especies de *Listroderes* Schoenherr del grupo *curvipes* (Coleoptera: Curculionidae). Rev. Chilena Entomol. 20: 15–21.
1994a. Systematics of the Andean genus *Acrororius* Kirsch (Coleoptera: Curculionidae). Coleopt. Bull. 48(2).
1994b. Clarification of the taxonomic status of the species formerly placed in *Listroderes* Schoenherr (Coleoptera: Curculionidae), with the description of a new genus. Am. Mus. Novit. 3093: 11 pp.
- In press a. Cladistic and biogeographic analyses of the weevil genus *Listroderes* Schoenherr (Coleoptera: Curculionidae). Cladistics.
In press b. Revisión de las especies de *Listroderes* Schoenherr del grupo *nodifer* (Coleoptera: Curculionidae). Bol. Mus. Nac. Hist. Nat. Chile.
In press c. Estudio taxonómico y bigeográfico del género subantártico *Falklandiellus* Kuschel (Coleoptera: Curculionidae). *Physis* (Buenos Aires).
- Morrone, J. J., and J. V. Crisci
1990. Panbiogeografía: Fundamentos y métodos. Evol. Biol. (Bogotá) 4: 119–140.
- Nelson, G.
1984. Cladistics and biogeography. In T. Duncan and T. F. Stuessy (eds.), Cladistics: Perspectives on the reconstruction of evolutionary history, pp. 273–293. New York: Columbia Univ. Press.

- Nelson, G. and P. Y. Ladiges
 1991a. Standard assumptions for biogeographic analyses. *Australian Syst. Bot.* 4: 41–58.
 1991b. TAS (MSDos computer program). Published by the authors, New York and Melbourne.
 1991c. Three-area statements: Standard assumptions for biogeographic analysis. *Syst. Zool.* 40: 470–485.
- Nelson, G., and N. I. Platnick
 1981. *Systematics and biogeography: Cladistics and vicariance*. New York: Columbia Univ. Press.
- Nixon, K. C.
 1992. CLADOS ver. 1.1. IBM PC-compatible character analysis program. Published by the author.
- O'Brien, C. W.
 1971. The biogeography of Chile through entomofaunal regions. *Entomol. News* 82: 197–207.
 1979. *Hyperodes*, new synonym of *Listronotus*, with a checklist of Latin American species (Cylyndrorhininae: Curculionidae: Coleoptera). *Southwest. Entomol.* 4(4): 265–268.
- Olliff, A. S.
 1891. Coleoptera-(continued). In E. Whymper, Supplementary appendix to travels amongst the Great Andes of the Equator, pp. 58–81. London: Murray.
- Page, R. D. M.
 1989. COMPONENT user's manual. Release 1.5. Published by the author, Auckland, New Zealand. 106 pp.
 1990. Component analysis: A valiant failure? *Cladistics* 6: 119–136.
- Ringuelet, R. A.
 1955. Ubicación zoogeográfica de las islas Malvinas. *Rev. Mus. la Plata, Zoología* 6: 419–464.
- Robinson, G. S.
 1984. *Insects of the Falkland Islands*. London: British Museum (Natural History), 38 pp.
- Schenkling, S., and G. A. K. Marshall
 1929. *Coleopterorum Catalogus*. Pars 106, vol. 28. Curculionidae: Byrsopinae, pp. 3–6; Rhytirrhinae, pp. 7–27; Thecesterninae, pp. 28–30; Hipporrhinae, pp. 31–46; Rhyparosominae, pp. 47–62. Berlin: Junk.
 1931. *Coleopterorum Catalogus*. Pars 114, vol. 28. Curculionidae: Eremninae, pp. 3–39; Leptopinae, pp. 1–83; Tanyrrhynchinae, pp. 1–10; Cylyndrorhininae, pp. 1–23; Thecesterninae (Suppl.), p. 1; Rhytirrhinae (Suppl.), pp. 1–4; Rhyparosominae (Suppl.), p. 4. Berlin: Junk.
- Schweiger, H.
 1958. Über einige von der Skottsbergexpedition im Antarkto-Archiplatea-Gebiet aufgesammelte Koleopteren. *Ark. Zool.* 12(1): 1–43.
- Sturm, H. and O. Rangel
 1985. *Ecología de los páramos andinos: Una visión preliminar integrada*. Bogotá: Instituto de Ciencias Naturales, Museo de Historia Natural, Biblioteca José Jerónimo Triana. 9.
- Voisin, J.-F.
 1987. Sur les Coléoptères des îles Falkland, notes et signalisations. *Bull. Soc. Entomol. France* 91(3–4): 93–95.
- Voss, E.
 1954. Curculionidae (Col.). Beiträge zur Fauna Perus 4: 193–376.
- Weidner, H.
 1979. Die entomologischen Sammlungen des Zoologischen Instituts und Zoologischen Museums der Universität Hamburg. *Mitt. Hamburgischen Zool. Mus. Inst.* 76: 395–468.
- Wibmer, G. J. and C. W. O'Brien
 1986. Annotated checklist of the weevils (Curculionidae sensu lato) of South America (Coleoptera: Curculionoidea). *Mem. Am. Entomol. Inst.* 39: xvi + 563 pp.
- Wiley, E. O.
 1988. Parsimony analysis and vicariance biogeography. *Syst. Zool.* 37: 271–290.

Recent issues of the *Novitates* may be purchased from the Museum. Lists of back issues of the *Novitates*, *Bulletin*, and *Anthropological Papers* published during the last five years are available free of charge. Address orders to: American Museum of Natural History Library, Department D, Central Park West at 79th St., New York, New York 10024. TEL: (212) 769-5545. FAX: (212) 769-5009. E-MAIL: scipubs@amnh.org